

Luxman

INTEGRATED AMPLIFIER

L-507Z

Owner's Manual

Contents

Precautions	1
Features of This Unit.....	2
Names and Functions.....	4
Connections	12
Operations.....	16
How to use Remote Control	18
Block Diagram.....	20
Specifications	21
Before Asking for Repair Services	22

Installation place

Install this unit in a location where good ventilation and heat radiation are assured. Especially, installation of this unit where direct sunlight is present, where the temperature rises excessively high such as close to a heater, or where it is humid or dusty may cause malfunctions even if the heat is efficiently released. Therefore, do not install this unit in such places.

Ventilation holes

The ventilation holes on the top and bottom panels of this product should never be blocked. If the amplifier is installed in closed rack or similar location, ensure ample space for cooling and leave the door open. Never place anything on top of the amplifier. Failure to observe these may cause malfunctions.

Note:

For heat dispersal, do not install this equipment in a confined space such as a book case or similar unit.

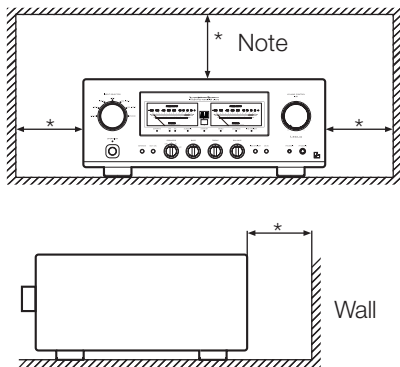

Batteries

Warning: Batteries used for the remote control shall not be exposed to excessive heat such as sunshine, fire or the like.

Cautions when connecting speakers

When connecting to a speaker system, exercise extra care not to short-circuit between the positive and negative connections of your speaker terminals or the speaker output terminals of this unit. If a large signal is applied to the amplifier while it is short-circuited, a large current may be passed through the output circuit and cause malfunctions.

Sound is not generated shortly after the power supply is turned on.

This amplifier is equipped with a timed muting circuit to protect the output. Therefore, no sound will be generated for a short time after the power supply is turned on.

If the volume control is set to a high-volume level before the timed muting circuit disengages, a loud, dangerous volume will be suddenly generated. Set the volume control to a low level first and then adjust it after you hear the output from the speakers.

Protection circuit

This product is equipped with a protection circuit that is activated upon detecting overcurrent, abnormally high temperatures and DC drifts to protect the amplifier and speakers. When the protection circuit is activated, the output to the speaker terminals will be shut off and the standby indicator will blink to show that this unit is muted. If the protection circuit is frequently activated, disconnect the AC plug from the wall outlet, wait for a while and then reconnect the plug to the wall outlet again and turn on the power. If the problem persists, please consult your dealer.

Repair and adjustment

When repairs or adjustments are needed, please consult the dealer who sold you the unit.

Cleaning

For cleaning, use a piece of soft fabric such as a cleaning cloth to wipe the unit. If dirt is hard to remove, use a small amount of neutral detergent to wipe it off and then wipe the unit with dry cloth. Do not use a solvent like benzine or thinner because they could damage the exterior.

Safety caution

Warning

This unit is heavy. Be careful when unpacking, carrying, and installing it.

Take care if you try to perform all the installation work yourself to avoid injury.

Features of This Unit

New LECUA 1000 — LUXMAN Electronically Controlled Ultimate Attenuator 1000

New LECUA 1000 attenuator is integrated into the amplifier circuitry. Electrically controlled fixed resistance switching enables fine sound volume adjustments from 0 dB through -87 dB with no deterioration in sound quality over the full range of the volume control.

LIFES — Luxman Integrated Feedback Engine System —

ODNF, LUXMAN's original amplification feedback circuitry, has been renewed, and LIFES, our newly developed feedback engine, is incorporated right at the heart of this amplifier, developing a richer sound quality.

Through adopting a dual FET into the input section of the sub amplifier, which detects the distortion of the sound signal, and adopting a dual transistor in the cascode circuit and current mirror circuit, sound quality has been improved throughout the amplification circuit with straightforward sound quality that seems to be created with a non-feedback amplifier and excellent high frequency characteristics thanks to the NFB.

Triple-paralleled push-pull output stages

Triple-paralleled bipolar transistors in push-pull configuration are used in the final output amplification stage providing a rated output of 110W+110W (8Ω) or 210W+210W (4Ω).

Highly stable power supply

The unit's highly stable power supply circuitry features a large capacity EI-core-type power transformer with 8 custom designed 10,000 μF blocking capacitors.

Parallel speaker relays

This unit is equipped with 2 large parallel speaker relays with a low resistance value to reduce the impedance of the speaker output lines.

Beeline construction

LUXMAN's Beeline construction ensures that the audio signal path takes the optimum shortest route from input to speaker output.

Selector switch IC

The selector switch IC, as used in our high-end C-900u control amplifier, supports high quality audio and improves input separation and crosstalk performance.

Schottky barrier diodes

By using Schottky diodes, manufactured by KYOCERA Corporation, this unit achieves very high DC conversion efficiency in the power rectifier circuitry and much less switching noise.

LUXMAN's original OFC wiring

Our original OFC cable, with non-plated core wire, is used for internal wiring to achieve smooth signal transmission.

Non-angled circuitry

After carefully considering the delicate nature of the audio signal flow, non-angled circuit board tracking has been adopted to achieve smooth signal transmission.

Phono amplifier

This unit is equipped with an integral phono amplifier adopted FET 2 parallel + OP amp compatible with the MM/MC cartridge to achieve high-quality analog record reproduction without the need for an external dedicated phono amplifier.

Separate function

This unit is equipped with a "SEPARATE" button used for separating the pre-amplifier and main-amplifier sections from each other. This enables bi-amp connections to an external power-amplifier and facilitates integration with an AV or home theatre system.

Loopless chassis structure

This unit features a loop-less chassis, independently constructed to eliminate increases in ground impedance due to chassis current.

Copper alloy RCA terminals

The RCA terminals used for the LINE-1 inputs are specially designed with the high conductivity of copper and the durability of brass.

18 mm pitch RCA terminals

We have used 18 mm pitch RCA input terminals for inputs other than LINE-1 to support high quality audio cables with large connectors.

Ventilation

A large ventilation holes on the top panel enhance the heat dissipation effect of the unit.

Cast-iron insulators

For stability and support, this product features cast iron feet with vibration reducing density gradient.

Hairline top panel

The top panel, with an elaborate hairline finish, is attached to the blasted white main body panels.

Large speaker terminals

The speaker terminals (A and B systems) have a separated inline layout (with the same characteristics for right and left) and are compatible with Y lugs to enable easy connection using extra-thick speaker cables.

Headphone output terminals

Enables you to enjoy listening on headphones. A 4.4mm terminal with ground separation is provided in addition to a standard 6.3mm terminal.

Needle type meter

This needle type meter with LED lighting appears beautiful in the listening room.

Visibility is excellent thanks to white illumination.

Aluminum remote controller

The high-grade, aluminum finished, hand-held remote can control compatible CD/SACD players as well as this unit.

Names and Functions

Front panel

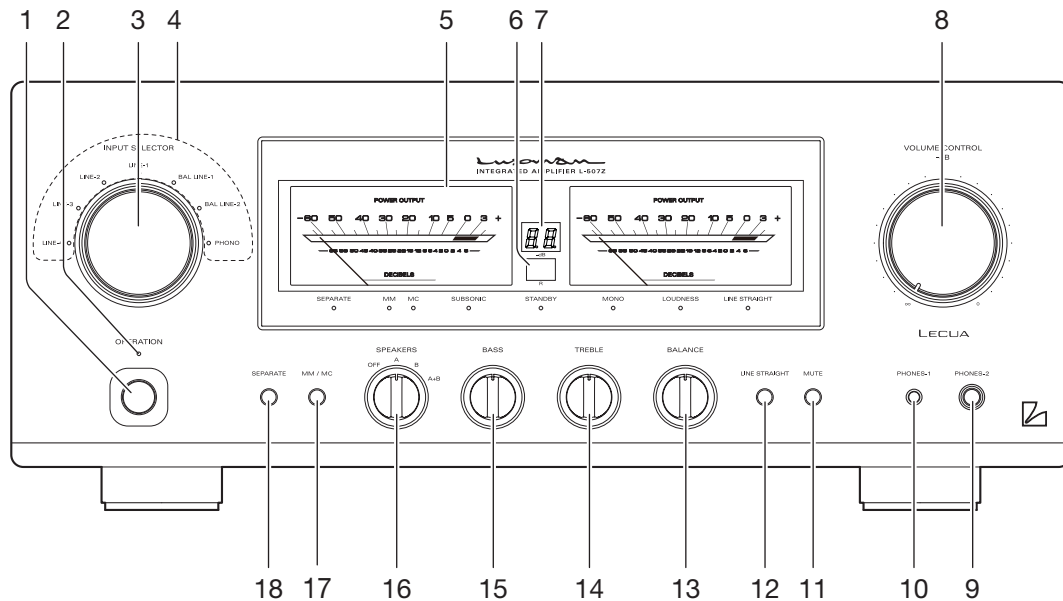

1. Operation button (OPERATION)

Turns the power on and off (standby state). When wiring or connection is performed, be sure to turn off this button.

2. Operation indicator (OPERATION)

Blinks during mute mode when the operation button is turned on and lights up when the operation state is reached after a short time. This indicator blinks when the unit is in the muting mode or the sound volume is adjusted with the remote control.

3. Input selector (INPUT SELECTOR)

Selects an input device, such as a CD player, an SACD player, a D/A converter, or a tuner connected to each input terminal.

The seven input selectors indicate LINE-4, LINE-3, LINE-2, LINE-1, BAL LINE-1, BAL LINE-2 and PHONO which correspond to the input terminals on the rear panel. Adjust the selector to the desired input..

4. Input indicators

The selected input's indicator will light up when using the input selector or remote control.

5. Display window

Displays the operation status of this unit.

This display is composed of 8 indicators, sound volume indicator, and 2 power meters.

6. Remote control infrared receiver (R)

Receives signals from the accessory remote control.

7. Sound volume indicator

Indicates the amount of volume attenuation in -dB.

8. Volume control (VOLUME CONTROL)

Adjusts the sound volume.

Sound will not be heard when this control is rotated fully counterclockwise. Volume will gradually increase as the control is rotated clockwise as follows: mute → -87 dB → -86 dB → ... → 0 dB in steps of 1 dB.

9. Phone jack (PHONES-2)

Insert your standard 6.3mm headphone plug into this output jack when listening with stereo headphones. Even when a headphone jack is inserted, signals to the speaker output terminal are not interrupted. To listen to music using only your headphones, set the speaker selector to OFF.

10. Phone jack (PHONES-1)

This jack is an output jack to be used with a 4.4mm stereo headphone plug.

Even when a plug is inserted in the same way as PHONES-2, signals to the speaker output terminal are not interrupted.

The PHONES-1 (di. 4.4) phone jack of this unit is a ground separation type connection model with an unbalanced amplifier.

Connection of compatible headphones allows you to enjoy listening with high separation performance thanks to independent wiring of right and left (-) signals.

11. Mute button (MUTE)

When this button is pressed and the mute function is activated, the operation indicator will start blinking and there will be no audio output.

Pressing this button again sets the mute function to off.

12. Line straight button (LINE STRAIGHT)

Enhances the purity of the sound quality by bypassing circuits such as balance control and tone control.

OFF (Line straight indicator off):

Line straight off/bypass off

ON (Line straight indicator on):

Line straight on/bypass on

- This button toggles the line straight function on and off.

The line straight indicator lights up when the line straight is set to on.

When the line straight button is set to on, the balance control, tone control, subsonic, monaural and loudness cannot be adjusted.

13. Balance control (BALANCE)

Adjusts the balance of sound volume between right and left channels.

Rotating the control counterclockwise gradually cuts the volume of the right channel, rotating the control clockwise gradually cuts the volume of the left channel.

This knob should be set to the center position under normal conditions, and rotated to make adjustment if necessary.

When the line straight button is set to on, this control cannot be adjusted.

14. Tone control for treble TONE CONTROL (TREBLE)

Controls the frequency characteristics of the high-frequency range.

Setting this control to the center position provides flat frequency characteristics. Rotating this control clockwise enhances the high-frequency range, and rotating this control counterclockwise attenuates the high-frequency range.

When the line straight button is set to on, this button does not function.

Names and Functions

Front panel

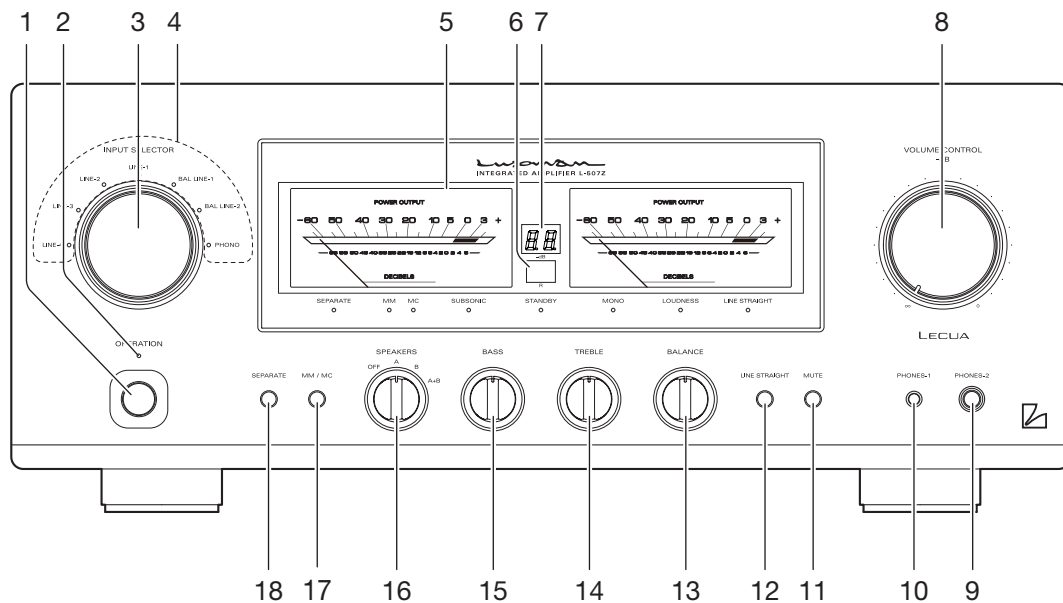

15. Tone control for bass TONE CONTROL (BASS)

Controls the frequency characteristics of the low-frequency range.

Setting this control to the center position provides flat frequency characteristics. Rotating this control clockwise enhances the low frequency range and rotating this control counterclockwise attenuates the low frequency range. When the line straight button is set to on, this button does not function.

16. Speaker selectors (SPEAKERS)

Selects either of 2 speaker systems, A or B, located at the rear panel.

OFF: Used when listening only with headphones and when not generating sound from speakers.

A (Center): Selects the A system speaker terminals.

B: Selects the B system speaker terminals.

A+B: Enables connection to 2 speaker systems. When using 2 speaker systems simultaneously, make sure they have an impedance of 8 ohms or more because the both output terminals are connected in parallel.

17. Cartridge button (MM/MC)

Selects the gain level of the equalizer amplifier (an amplifier circuit necessary for playing an analog records).

Each time this button is pressed, the selection will toggle between MM and MC.

MC: Selects a low output voltage MC (moving coil) type cartridge.

When MC is selected while using an MM type cartridge, be aware that the sound volume becomes higher and an unbalanced sound lacking high frequencies will be heard owing to the incorrect impedance.

MM: Selects a high output voltage MM (moving magnet) type cartridge.

18. Separate button (SEPARATE)

Separates the pre-amplifier and main-amplifier each other.

OFF (Separate indicator off):

Returns this unit to normal integrated amplifier mode.

ON (Separate indicator on):

Feeds external signals from the MAIN IN terminal on the rear panel to the main-amplifier section.

- This button toggles the separate on and off.

The separate indicator lights up when separate on is selected.

When the separate button is set to on, the volume control of this unit cannot adjust the volume of the speakers connected to this unit. Volume adjustment should be performed at the input device side such as a control amplifier connected to the MAIN IN terminal.

Connection from direct output into the MAIN IN terminal from a CD player or other devices which don't have a volume control always provides full power and accordingly there is a risk of speaker damage.

For such input devices, be sure to use a control amplifier equipped with volume adjustment, begin feeding audio to the speakers with the volume low and adjust the volume to your preferred level. When connecting devices to this unit, be sure to turn off the power to prevent damage.

Names and Functions

Display window

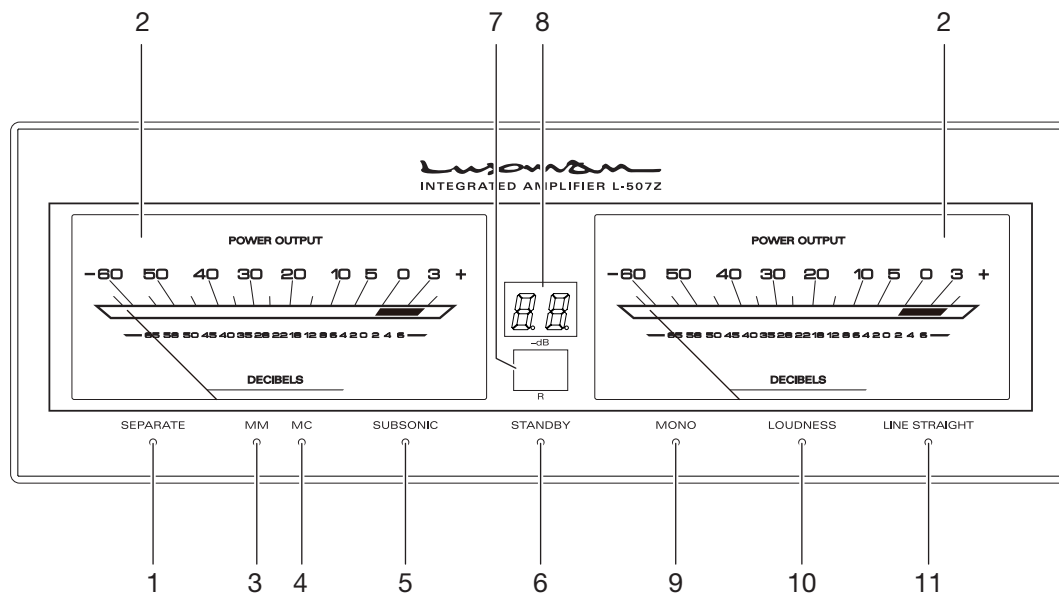

1. Separate indicator (SEPARATE)

Lights up when the separate button is set to on.

2. Power meters

Indicate the output of the L channel on the left side and the output of the R channel on the right side. The meter indicates the output in decibels.

When the power is turned on, the meters light up.

3. MM cartridge indicator (MM)

Lights up when the cartridge button is set to MM.

4. MC cartridge indicator (MC)

Lights up when the cartridge button is set to MC.

5. Subsonic indicator (SUBSONIC)

Lights up when the subsonic button is on.

The subsonic, monaural and loudness functions can be toggled only from the accessory remote control (RA-17A).

6. Standby indicator (STANDBY)

Lights up when the connected AC cable is plugged into a wall socket and the operation button is set to off (standby state).

When the power is turned on or the AC plug is disconnected from a wall socket, this indicator is turned off. This indicator blinks when the protection circuit is activated.

7. Remote control infrared receiver (R)

Receives signals from the accessory remote control.

8. Sound volume indicator

Indicates the amount of volume attenuation in -dB.

9. Monaural indicator (MONO)

Lights up when the monaural button is on.

10. Loudness indicator (LOUDNESS)

Lights up when the loudness button is on.

The subsonic, monaural and loudness functions can be toggled only from the accessory remote control (RA-17A).

11. Line straight indicator (LINE STRAIGHT)

Lights up when the line straight button is on.

When the line straight button is set to on, the subsonic, monaural and loudness functions cannot be operated from the supplied remote control.

If these buttons are pressed, the line straight indicator blinks for 3 seconds to let you know these functions cannot be operated.

If you would like to operate subsonic, monaural, or loudness function, set the line straight switch to off, and then operate such functions.

Names and Functions

Rear panel

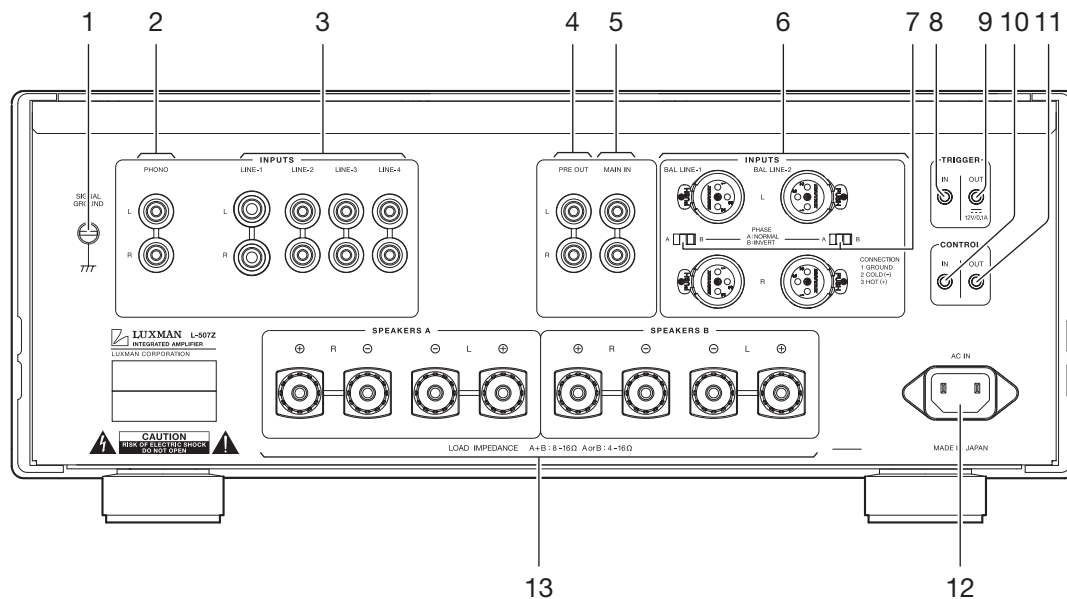

1. Signal ground (Ground terminal) (SIGNAL GROUND)

The ground terminal is for a device such as analog player connected to this unit. This terminal is used to reduce noise when other devices are connected. This terminal is not an electrical safety feature.

2. Phono input terminals (PHONO)

Input terminals to connect an analog player.

Do not connect a CD player or other devices with high output levels to these terminals.

CD or other line level signals will be distorted.

3. LINE-1, LINE-2, LINE-3, LINE-4 input terminals (unbalanced) (LINE-1, LINE-2, LINE-3, LINE-4)

Used for line level signal inputs from CD players, SACD players, D/A converters, tuners, DVD players, TVs and other such devices. The input sensitivity is 180 mV and the impedance is 47 kΩ. Copper alloy terminals are used only for LINE-1. These input terminals offer the same functions.

4. Pre-out terminals (PRE OUT)

These terminals are used to obtain the output of the preamplifier. A bi-amp connection can be performed with a combination of an external power amplifier because these terminals always provide output regardless of the separate button setting.

Do not insert shortpin plugs into PRE OUT.

No sound will be generated.

5. Main in terminals (MAIN IN)

Provide input to the main-amplifier section when the pre-amplifier and main-amplifier are separated by setting the separate button to on.

6. Balanced input terminals/INPUTS (BAL LINE-1, BAL LINE-2)

The balanced type input terminals of the LINE level for an XLR connector.

7. Phase inverters (PHASE)

Reverse the phase when the balance input terminals are used. The phase should be corresponding to the phase of the input device.

- A: NORMAL position ① GROUND
 ② COLD (-)
 ③ HOT (+)
- B: INVERT position ① GROUND
 ② HOT (+)
 ③ COLD (-)

8. Trigger input terminal (TRIGGER IN)

Connection to a device with a trigger output terminal to this trigger input terminal enables this unit to switch to operation or standby modes in conjunction with the connected device.

9. Trigger output terminal (TRIGGER OUT)

Connection of this trigger output terminal to a device having a trigger input terminal enables the connected device to turn to operation or standby in conjunction with this unit.

10. Control input terminal (CONTROL IN)

Connects a LUXMAN's device with a control output terminal using a commercially available 3.5-mm monaural mini-jack cable. This connection enables the infrared receiver circuit of the connected device to receive signals from the remote control supplied with this unit and the remote control to operate the device, too.

(The infrared receiver of this unit will not function.)

11. Control output terminal (CONTROL OUT)

Connects a LUXMAN's device with a control input terminal using a commercially available 3.5-mm monaural mini-jack cable. This connection enables the infrared receiver of this unit to receive signals from the remote control of the connected device and the remote control to operate this unit, too.

(The infrared receiver of the device whose input is connected will not function.)

12. AC inlet (AC IN)

Connects the accessory power cable. The power should be supplied from a household wall socket.

13. Speaker terminals (SPEAKERS)

Connects a speaker system.

Connect the left speaker terminal to the left side and the right speaker terminal to the right side paying attention to the polarity.

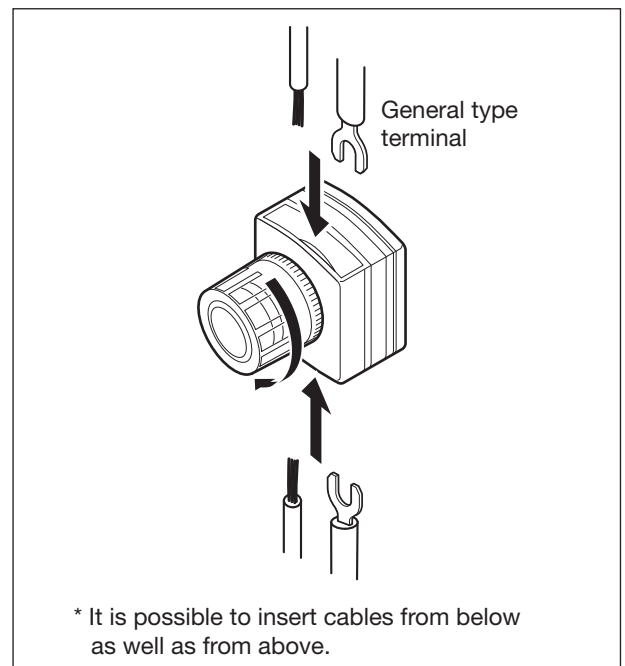

- Do not bring the core wire of the speaker cable into contact with the core wires of other speaker cables or the metal parts of this unit. Failure to observe this may cause a malfunction of this unit or the speakers.
- When the power of this unit is set to on, do not touch the metal parts of the terminals or the core wires of the cables. Failure to observe this may result in an electric shock.

Connections

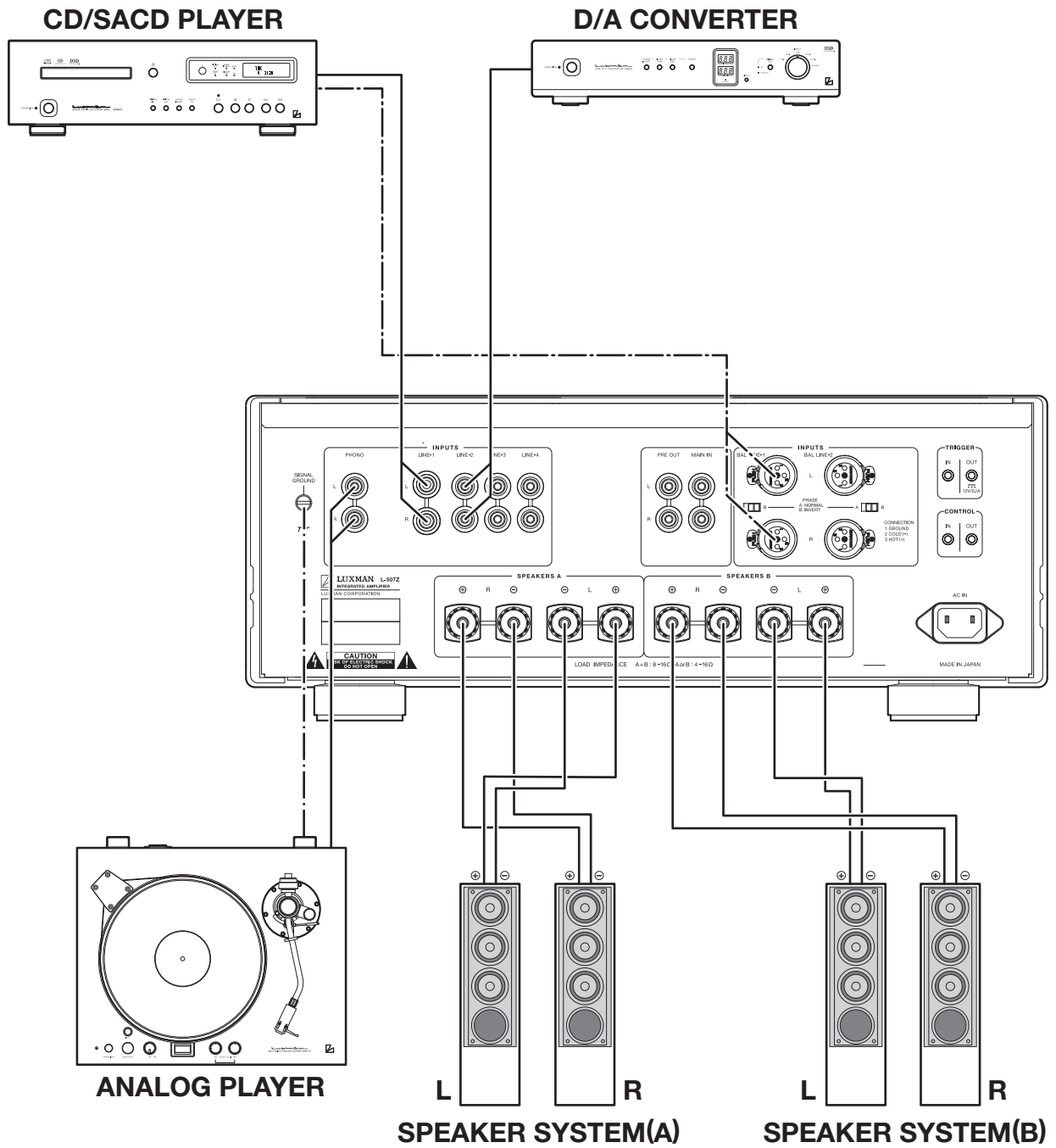

Before Connecting

Before connecting other devices, connect the jack side of the accessory power cable to the AC inlet of this unit.

When connecting, turn off the power supply for this unit and the power supplies of all auxiliary devices to prevent unexpected accidents that may be caused by noise.

Connecting to the power supply

Insert the accessory power supply cable plug into an AC outlet on the wall of the listening room.

How to connect CD players, SACD players, D/A converters, tuners and other devices

Connect between the output terminals of the CD player, SACD player, D/A converter, tuner or other such input devices and the LINE-1 input terminals of this unit with 2 (R and L) pin-plug cables or balanced cables.

For LINE-2, LINE-3, and LINE-4 input terminals, connection in the same fashion as the LINE-1 terminals.

How to connect speakers

Connect the left-channel speaker to the SPEAKERS-L terminal and the right-channel speaker to the SPEAKERS-R terminal on the rear panel of this unit.

Securely connect the \oplus terminal of the speaker system to the \oplus speaker terminal (red) of this unit, and the \ominus terminal of the speaker system to the \ominus speaker terminal (black) of this unit. If the \oplus and \ominus terminals are connected in reverse to either the right or left speaker systems, the acoustic phases of the sound reproduced from the right and left speaker systems are also reversed. In such a case, be aware that the low frequency sound levels will be reduced and the acoustic stability will worsen, thus failing in normal stereo playback.

How to connect between the trigger input terminal and other devices

Use a commercially available 3.5 mm monaural mini-plug cable to connect to a device with a trigger output terminal. This connection enables this unit to turn to operation/standby in conjunction with the connected device.

When connection is conducted from a product made by other than LUXMAN, make sure that the trigger output is 12 V. The trigger input of this unit should be 12 volts, the power consumption is 13 mA.

How to connect between the trigger output terminal and other devices

Use a commercially available 3.5 mm monaural mini-plug cable to connect to a device with a trigger input terminal. This connection enables the connected device to turn to operation/standby in conjunction with this unit.

The maximum output current that can be supplied from this unit is 12 V is 100 mA. Be aware that a malfunction may be caused if a load more than the above is applied to this unit by connecting such a device or causing a short circuit.

Connections

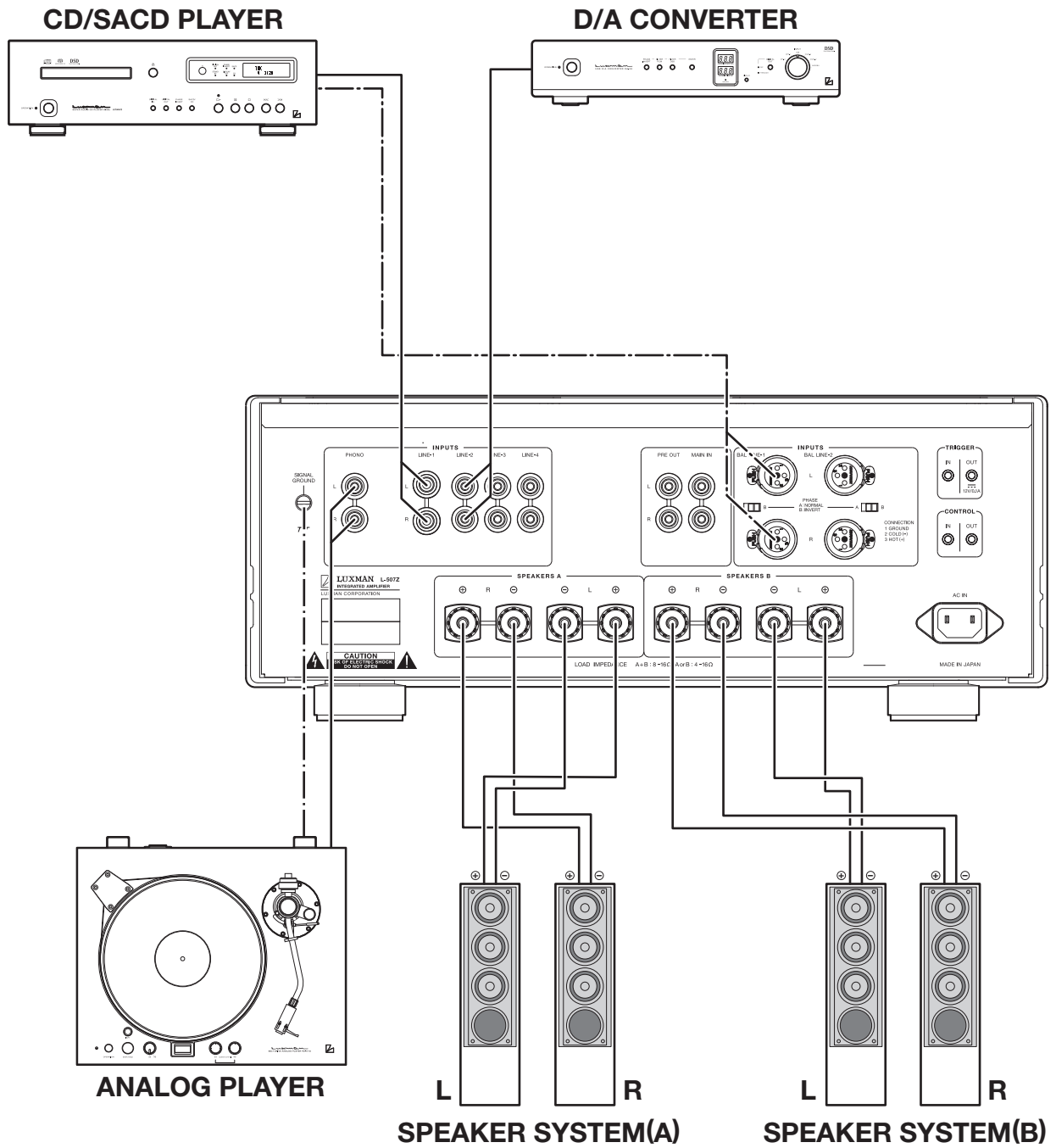

How to connect an analog player

Connect the output terminals of an analog player and the PHONO terminals of this unit with 2 (R and L) pin-plug cables. For most analog players, the ground wire from the phono motor or the tone arm should be connected to the ground terminal of this unit.

This unit's phono equalizer is compatible with MM and MC cartridges. When an MC cartridge with low output voltage is used, set the cartridge button on the front panel to the MC position.

The output from an analog player equipped with its own phono equalizer or from an independent phono equalizer should be connected to the line input terminals of this unit.

How to connect PRE OUT/MAIN IN terminals

Either the pre-amplifier or main-amplifier can be separately used.

When the pre-amplifier or main-amplifier is used separately, set the separate button on the front panel to on. When only the pre-amplifier is used, connect the PRE OUT terminals of this unit to the input terminals of another power-amplifier, and when only the main-amplifier is used, connect the MAIN IN terminals of this unit to the output terminals of another device.

When this amplifier is used without separating between the pre-amplifier and main-amplifier, set the separate button on the front panel to off, or no sound will be generated.

Do not insert short-pin plugs into PRE OUT. No sound will be generated.

Operations

Before operation

1. Ensure that all connections have been correctly performed. (Normal playback cannot be achieved with incorrect connections of R, L, ⊕ or ⊖.)
2. Before the power is toggled between on and off or an input selected, be sure to set the volume control to the minimum position.

Playback procedure

1. Press the operation button to turn on the unit after ensuring that the volume control is set to the minimum position.
2. Select a source to be reproduced with the input selector.
3. Adjust the sound level with the volume control.
4. Operate the line straight button, balance control and tone controls according to taste.

Line straight selection

The line straight button is used to reproduce audio via the shortest audio signal route for enhancing the clarity of the source selected. When this button is set to on, the balance control, tone controls, subsonic, monaural and loudness functions are bypassed.

Balance control operation

The balance control enables users to adjust the balance of sound volume between the right and left channels. When the balance adjustment is not required, the balance control should be set to the center position.

When the line straight button is set to on, the balance control will not function.

Tone controls

This unit has a tone controls for the low and high frequency ranges.

The low frequency range is effective at 300 Hz or lower. This tone control has flat frequency characteristics at the center position. Rotating the control clockwise enhances the low-frequency range, and rotating the control counterclockwise attenuates the low-frequency range.

The high frequency range is effective at 3 kHz or higher. This tone control is set to flat frequency characteristic at the center position. Rotating the control clockwise enhances the high-frequency range, and rotating the control counterclockwise attenuates the high-frequency range.

For both the low and high-frequency ranges the effects on both right and left channels are matched.

When the line straight button is set to on, the tone control does not function.

Memory

This unit stores the following items when the power is off:

Item	Default
INPUT	Selected source
METER	on/off
Sound volume indicator	on/off
SUBSONIC	on/off
MONO	on/off
LOUDNESS	on/off
LINE STRAIGHT	on/off
SEPARATE	on/off
MM/MC	MM/MC

Memory reset

All settings can be restored to the factory defaults by the following steps:

- (1) Turn off the power of this unit.
- (2) Hold down the operation button on the main unit for 5 seconds or more and press the line straight button on the front panel once while holding down the operation button.

The power state will switch from on to off.

This will fully reset the memory.

Factory default

Item	Default
INPUT	LINE-1
METER	on
Sound volume indicator	on
SUBSONIC	on
MONO	off
LOUDNESS	off
LINE STRAIGHT	off
SEPARATE	off
MM/MC	MM

How to use Remote Control

Remote control (RA-17A)

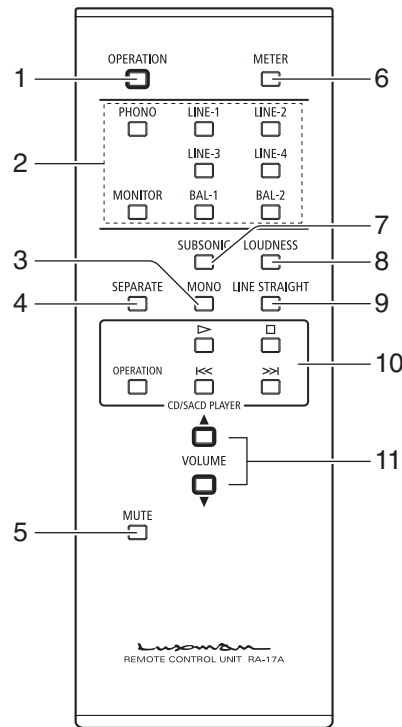

1. Operation button (OPERATION)

Turns the power on and off (standby state). When wiring or connection is performed, be sure to turn off this button.

2. Input selector (LINE-1, LINE-2, LINE-3, LINE-4, BAL-1, BAL-2, PHONO, MONITOR)

Selects between input sources from among the input terminals on the rear panel consisting of LINE-1, LINE-2, LINE-3, LINE-4 and PHONO or the balanced BAL LINE-1 and BAL LINE-2 input.

For reference, MONITOR has no effect on this unit.

3. Monaural button (MONO)

Mixes the signals from the right and left channels into mono. The monaural indicator lights up when this button is pressed.

Press the button again to turn off the monaural effect and reproduce a regular stereo output.

* |When the line straight button is set to on, this button will not function.

4. Separate button (SEPARATE)

Separates the pre-amplifier and main-amplifier sections from each other.

OFF (Separate indicator on):

Returns this unit to normal integrated amplifier mode.

ON (Separate indicator off):

Feeds external signals from the MAIN IN terminal on the rear panel to the main-amplifier section.

- Holding down this button for 1 second toggles the SEPARATE state on and off.

The separate indicator lights up when separate is selected.

5. Mute button (MUTE)

When this button is pressed and the mute function is activated, and the operation indicator will start blinking and there will be no audio output. Pressing this button again sets the mute function to off.

6. Meter button (METER)

Turns off the meter lights. The meter lights and sound volume indicator are turned off.

Pressing this button changes the state as follows:

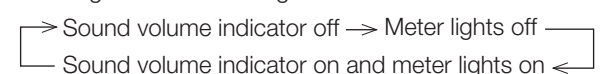

When the sound volume is operated while the sound volume indicator is in the off state, the sound volume indicator is turned on for approx. 4 seconds and then turned off.

7. Subsonic button (SUBSONIC)

Cuts ultra-low frequencies outside the audible range to prevent ultra-low range noise from adversely affecting the audible range.

This function is especially effective when an analog record is warped, or a woofer is shaking owing to ultra-low frequency range overload.

- This button toggles the subsonic function on and off.

The subsonic indicator lights up when the subsonic on is selected.

* When the line straight button is set to on, this button will not function.

8. Loudness button (LOUDNESS)

Compensates the characteristics of human ears that cause difficulty in hearing to low-pitched and high-pitched sounds at low sound volume.

- This button toggles the loudness on and off.

The loudness indicator lights up when the loudness on is selected.

* When the line straight button is set to on, this button will not function.

9. Line straight button (LINE STRAIGHT)

Enhances sound quality and clarity by bypassing the balance control circuit, tone control circuit and other signal processing.

OFF (Line straight indicator off):

Line straight off/bypass off

ON (Line straight indicator on):

Line straight on/bypass on

- This button toggles the line straight function on and off.

The line straight indicator lights up when the line straight is set to on.

10. CD/SACD player operation button (CD/SACD PLAYER)

These buttons are used to control the supported CD/SACD players.

The supported CD/SACD players are the following 14 models as of October 2021: D-10X, D-03X, D-N150, D-380, D-08u, D-06u, D-05u, D-08, D-06, D-05, D-10, D-7, D-600S and D-700S.

11. Volume control switches (VOLUME, ▲, ▼)

Adjusts the sound volume.

- Pressing ▲ increases the sound volume in steps of 1 dB.
- Pressing ▼ decreases the sound volume in steps of 1 dB.

Remote control

The remote control should be aimed at the remote sensor of this unit within the specified angle range as shown in the illustration.

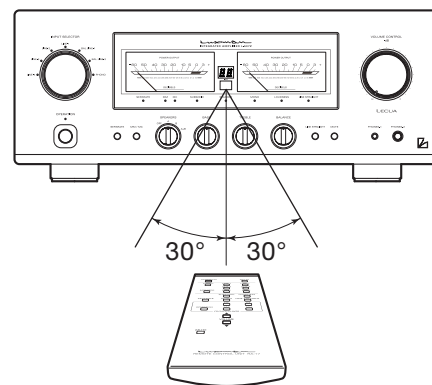

Effective distance:
approx. 5 meters

Dry cell

[How to load dry cells]

1. Put your finger on the battery cover claw on the rear of the remote control and slide the cover downward to open it.
2. Put 2 AAA batteries in the battery case as shown in the illustration.
3. Close the battery cover.

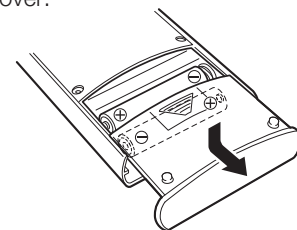

-
- Do not use a combination of new and old batteries together.
 - There may be a case in which the voltages are different between two batteries even though they are the same size. Do not use batteries of different types together.
 - If the remote control is not used for a long time (more than 1 month), the batteries should be removed from the case. If battery fluid is leaking, wipe away the liquid from the case before inserting new batteries.
 - To discard exhausted batteries, follow the instructions from your local authority.
-

Block Diagram

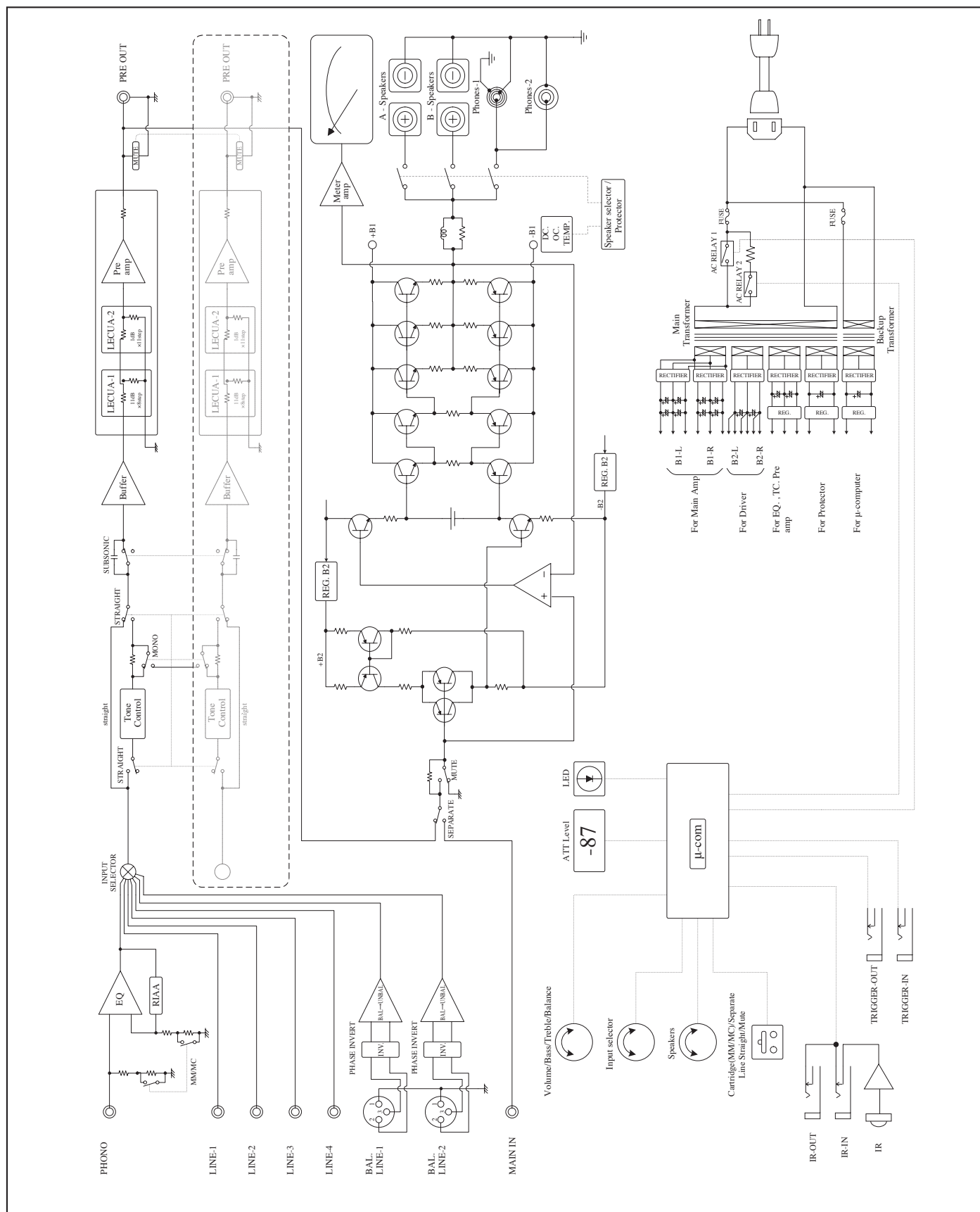

Specifications

luxman
INTEGRATED AMPLIFIER L-507Z

Rated output	110 W+110 W (8 Ω) 210 W+210 W (4 Ω)	
Total harmonic distortion	0.007 % (8 Ω, 1 kHz for both channels simultaneously, line straight on) 0.03% (8 Ω, 20 - 20 kHz for both channels simultaneously, line straight on)	
Pre-amplifier Input sensitivity/input impedance	PHONO (MM) PHONO (MC) LINE BAL. LINE	: 2.5 mV / 47 kΩ : 0.3 mV / 100 Ω : 180 mV / 47 kΩ : 180 mV / 79 kΩ
Main-amplifier Input sensitivity/input impedance	MAIN IN	: 1.05 V / 47 kΩ
Output voltage	PRE OUT	: 1 V
S/N ratio	PHONO (MM) PHONO (MC) LINE	: 91 dB or more (IHF-A correction, 5 mV input) : 75 dB or more (IHF-A correction, 0.5 mV input) : 105 dB or more (IHF-A weighted, input shorted, line straight on)
Frequency response	PHONO (MM) PHONO (MC) LINE	: 20 Hz to 20,000 Hz (±0.5 dB, line straight on) : 20 Hz to 20,000 Hz (±0.5 dB, line straight on) : 20 Hz to 100,000 Hz (within -3 dB, line straight on)
Tone control	Max. amount of change	BASS : ±8 dB at 100 Hz TREBLE : ±8 dB at 10 kHz
Loudness control	100 Hz 10 kHz	: +7 dB : +5 dB
Damping factor		: 300
Supplied functions	<ul style="list-style-type: none"> • Power meter • Sound volume indicator • Speaker selectors (OFF, A, B, A+B) • Monaural button (remote control) • Tone control • Phone jack (1, 2) • Phase inverter button • Cartridge button (MM/MC) • Mute button • Balance control • Subsonic button (remote control) • Separate button • Line straight button • Loudness button (remote control) 	
Accessories	<ul style="list-style-type: none"> • Remote controller RA-17A • Owner's Manual (This document) • Safety caution • Power cable • Two "AAA" batteries 	
Power supply	230 V ~ (50 Hz)	
Power consumption	350 W 0.4 W (at standby), 86 W (at no input)	
Max. external dimensions	440 (W) x 178 (H) x 454 (D) mm (front side knob with 20 mm and rear side terminal with 27 mm included in depth)	
Weight	25.4 kg (main unit)	

* Specifications and appearance are subject to change without notice.

Before Asking for Repair Services

While in use, this unit may display phenomena which may be confused as malfunctions. Before contacting your country's official LUXMAN distributor for repair services, please read the operating instructions for any connected input and output devices and check the troubleshooting table below. If the cause of the malfunction cannot be identified, please contact your dealer. After LUXMAN's representatives have accepted your request for repair services, inspection fees and transportation expenses may be claimed, even though the unit may be found to be operating normally.

Problem	Cause	Solution
No power is supplied even though the operation button is pressed.	<ul style="list-style-type: none"> • The power plug is disconnected from the wall outlet, or it is not completely inserted. • The power plug is disconnected from the AC inlet or is not completely inserted. 	<ul style="list-style-type: none"> • Insert the power plug completely into the wall outlet. • Securely insert the power plug into the AC inlet.
No sound is generated.	<ul style="list-style-type: none"> • The volume control is set to the minimum level. • The source to be reproduced is not selected with the input selector. • Cable connections are incomplete. • The output level of the input device is set to the minimum position. • The separate button is set to on. • The mute button of the remote control is set to on. 	<ul style="list-style-type: none"> • Rotate the volume control clockwise to adjust the sound volume. • Select the source to be reproduced with the input selector. Select a source with the input selector buttons. • Make cable connections securely. • Adjust the output level. • Set the separate button to off. • Set the mute button to off.
No sound is generated on one side.	<ul style="list-style-type: none"> • The balance control is fully rotated. • The input or output cables are not connected on one side. 	<ul style="list-style-type: none"> • The balance control shall be set to the center position under normal conditions. • Make cable connections securely.
Humming sound is generated.	<ul style="list-style-type: none"> • The ground side of the pin-plug cable has no contact with the terminal. • The ground wire of the analog record player is not connected. • Connections or mounting conditions are incomplete between the cartridge and shell, or between the shell and tone arm of the analog record player. 	<ul style="list-style-type: none"> • Make connections securely so that the ground side of the pin-plug cable can be connected. • Connect the ground wire of the analog record player to the GND terminal. • Connect (or mount) the cartridge, shell, and tone arm securely.
No effect of tone control or balance control is observed.	<ul style="list-style-type: none"> • The line straight button is set to on. 	<ul style="list-style-type: none"> • When tone control or balance control are used, the line straight button should be set to off.
The subsonic, monaural or loudness is not activated.	<ul style="list-style-type: none"> • The line straight button is set to on. 	<ul style="list-style-type: none"> • When the subsonic, monaural or loudness is used, the line straight button should be set to off.
The power meter light is not turned on.	<ul style="list-style-type: none"> • The meter on/off setting is set to off. 	<ul style="list-style-type: none"> • Set the setting to on with the meter on/off button of the remote control.
The separate button of the remote control is not activated.	<ul style="list-style-type: none"> • To prevent incorrect operations, this unit is designed to toggle the separate on/off by holding down the separate button for approximately 1 second. 	<ul style="list-style-type: none"> • Hold down the separate button of the remote control for approximately 1 second.

MEMO

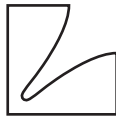

LUXMAN CORPORATION, JAPAN

1-3-1 Shinyokohama, Kouhoku-ku, Yokohama-shi, Kanagawa 222-0033, Japan

AG00238G04A
Printed in Japan