

Luxman

VACUUM TUBE INTEGRATED AMPLIFIER

LX-380

Owner's Manual

Contents

Precautions	1
Features of This Unit	2
Names and Functions	4
Connections	10
Operations	14
How to Use Remote Control	15
Block Diagram	16
Specifications	17
Before Asking for Repair Service	18

Installation place

Install this unit in a location where good ventilation and heat radiation are assured.

Especially, the installation of this unit where the direct sunlight is present, where the temperature rises excessively high such as close to a heater, or where it is humid or dusty may cause a malfunction even if heat is efficiently released. Therefore, do not install this unit in such places.

Ventilation holes

Do not block the ventilation holes of the top and bottom panels. If the amplifier is installed on a rack or the like, secure ample space for cooling and leave the door open. Do not pile up other things on the amplifier and never put articles on it. Failure to observe this may cause a malfunction.

Note:

For heat dispersal, do not install this equipment in a confined space such as a book case or similar unit.

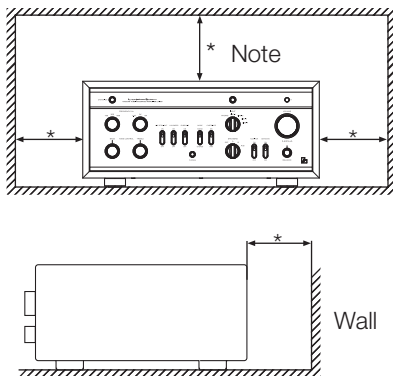

Precautions in connecting with other components

When connecting this unit to input devices such as a CD player, an SACD player, an analog player, a tuner, and a recorder, be sure to turn off the power of this unit and all other connected devices. Failure to observe this may generate a strong noise resulting in speaker damage or cause a malfunction. The pin-plug to be inserted in each input terminal of this unit shall be pushed in firmly. If the grounding terminal is inadequately connected, noises including hum may be generated, resulting in an adverse S/N ratio.

Batteries

Warning:

Batteries used for the remote control shall not be exposed to excessive heat such as sunshine, fire or the like.

Cautions in connecting speakers

When making speaker system connections, exercise extra care not to short-circuit between (+) and (-) of the speaker terminals and speaker input terminals of this unit. If a large signal is applied to the amplifier with its circuit left short-circuited, a large current may be passed through the output circuit and cause a malfunction.

The sound is not generated shortly after the power supply is turned on.

This amplifier is equipped with a time muting circuit in order to separate the output circuit. Therefore, no sound will be generated shortly after the power supply is turned on.

If the volume control is set to a high sound level before the time muting circuit is canceled, a large sound is suddenly generated. Please be advised that the volume control shall be set to a low level at first and adjusted after the sound comes out of the speakers.

Repair and adjustment

When repairs or adjustments are needed, please ask the dealer where you bought the unit.

Cleaning

For cleaning, use a piece of soft cloth to wipe the unit such as cleaning cloth. When the dirt is hard to remove, use a small amount of neutral detergent to wipe, and then wipe the unit with dry cloth. Do not use a solvent like benzine or thinner because such substances can often damage the exterior.

Safety caution

Caution

- This unit is heavy. Be careful when unpacking, carrying, and installation.
- This unit is a vacuum tube control amplifier. Be careful not to touch this product with your bare hand because it gets hot when the power is on. For safety, do not use this product in a place where children or unchained animals are present.



Hot surface mark

HOT SURFACE. DO NOT TOUCH.

The top surface over the vacuum tube may become hot when operating this product continuously.

Do not touch hot areas, especially around the "Hot surface mark" and the top panel.

Features of This Unit

Wooden case

A traditional square-shaped wooden case is used.

Beam tetrode connection / push-pull output stage

Push-pull configuration with 6L6GC beam tetrode connection

Phono amplifier

This unit is equipped with a phono amplifier that is compatible with the MM/MC cartridge to achieve analog record playback in a high-grade level without adding a dedicated phono amplifier.

Tone control

A bass/treble type tone control function that enables fine sound volume adjustment with a 3-step turnover frequency selector switch is equipped.

LECUA-LUXMAN Electric Controlled Ultimate Attenuator

An electrically controlled attenuator LECUA is mounted. It attenuates the signal level by combined resistances.

By using an exclusive solid-state IC and controlling the attenuator to the level equal to the angle of the volume knob position, you can feel the similar touch of our traditional sliding-type volume control.

Subsonic, monaural function

A subsonic switch that controls woofer shaking generated by warp of the analog record, and a monaural switch to be used during monaural playback are provided.

Headphone output terminal

This terminal allows you to casually enjoy music with headphones.

Separate function

This unit is equipped with a separate switch to separate the pre-amplifier and power-amplifier each other that enables the bi-amp connection adding a power-amplifier and the coexistence with an AV system.

Selector switch IC

Selector switch IC with high sound quality, which is used in the top-end control amplifier, C-900u, improves the separation and crosstalk performances.

Input/output for recorder

An input/output terminal to connect a recorder such as a tape deck is equipped.

High sound quality relay

Reliable design for the signal switch is achieved by using an audio-specific relay of high durability.

Machined aluminum knob

Classical type machined aluminum control knobs with dignified look are furnished.

18 mm pitch RCA terminal

All of RCA input/output terminals are 18 mm pitch allowing high-performance line cables with large plugs to be connected.

Large type speaker terminals

Speaker terminals (A and B systems) of inline layout (with same characteristics for right and left), which is compatible with Y lugs for easy connection with extra-thick speaker cables.

Aluminum remote control

The high-grade remote control, which is encased in aluminum, can control applicable CD/SACD players as well.

Highly reliable design

Both prolonged life and highly reliable design of vacuum tubes have been achieved by providing operating conditions of vacuum tubes with some allowance.

Names and Functions

Front panel

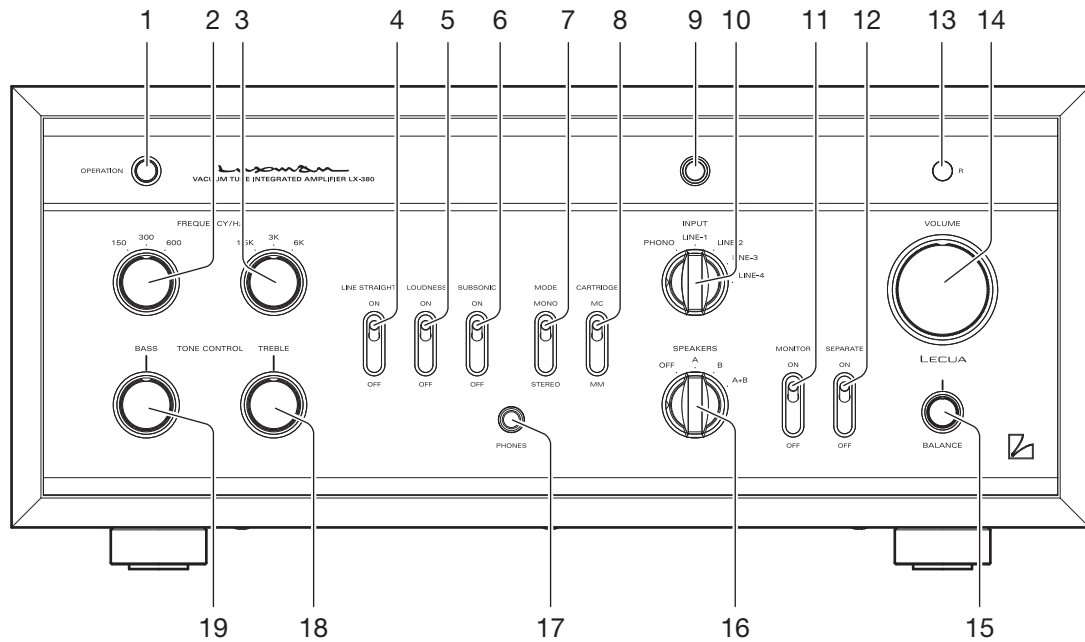

1. Operation switch (OPERATION)

Turns on and off the power. When wiring or connection is performed, be sure to turn off this switch. When turning on the power switch again after turning the unit off, wait for more than one minute.

2. Low frequency selector switch (FREQUENCY/Hz)

Toggles to select frequencies from 150 Hz, 300 Hz, 600 Hz. For example, when 150 Hz is selected, the frequencies of 150 Hz and lower can be adjusted by the tone control for bass.

3. High frequency selector switch (FREQUENCY/Hz)

Toggles to select frequencies from 1.5 kHz, 3 kHz, 6 kHz. For example, when 1.5 kHz is selected, the frequencies of 1.5 kHz and higher can be adjusted by the tone control for treble.

4. Line straight switch (LINE STRAIGHT)

Enhances the purity of the sound quality by bypassing the balance control circuit, tone control circuit, or the like.

OFF: Line straight off/bypass off

ON: Line straight on/bypass on

When the line straight switch is set to on, the balance control, tone control, subsonic, monaural and loudness cannot be adjusted and the mode selector does not function.

5. Loudness switch (LOUDNESS)

OFF: Provides the normal state.

ON: Corrects the characteristics of human ears that causes difficulty in listening to low-pitched and high-pitched sounds when the sound volume is low.

* When the line straight switch is on, this function will be "off" and does not function.

6. Subsonic switch (SUBSONIC)

Toggles the ultra-low frequency cutoff function on and off.

OFF: Provides the normal state.

ON: Cuts ultra-low frequencies out of audible range to prevent ultra-low range noise from adversely affecting audible range. This function is significantly effective especially when an analog record is warped or a woofer is shaking owing to ultra-low range vibration.

* When the line straight switch is on, this function will be "off" and does not function.

7. Mode switch (MODE)

Changes the output mode.

MONO: Mixes the signals from right and left channels to provide monaural playback.

STEREO: Provides normal stereophonic playback.

* When the line straight switch is on, this function will be "stereo" and does not function.

8. Cartridge selection switch (CARTRIDGE)

Changes the gain level of the equalizer amplifier (amplifier circuit required to play an analog record).

MC: Selects the MC (moving coil) type cartridge of low output voltage.

Be aware that the sound volume becomes higher and unbalanced sound without high frequencies is generated owing to the impedance when "MC" is selected during use of the MM type cartridge.

MM: Selects the MM (moving magnet) type cartridge of high output voltage.

9. Pilot light

Blinks in the time of muting mode when the operation switch is turned on and lights up when the operation state is activated afterward. This indicator blinks when the unit is in the muting mode or when the volume is adjusted with the remote control.

10. Input selector (INPUT)

Selects an input device from the devices such as a CD/SACD player and a tuner connected to each input terminal. This selector has 5 positions consisting of PHONO, LINE-1, LINE-2, LINE-3, and LINE-4 that correspond to each input terminal on the rear panel. To select an input source, set the selector to the position of the source to be played back.

11. Monitor switch (MONITOR)

Selects the monitor input terminal (MONITOR) on the rear panel.

ON: Enables to play back the data from the recorder.

OFF: Enables to play back the data from the source selected with the input selector.

12. Separate switch (SEPARATE)

Separates the pre-amplifier and main-amplifier each other.

OFF: Uses this unit as a normal integrated amplifier.

ON: Feeds external signals from the MAIN IN terminal on the rear panel to the main-amplifier section.

When the separate switch is set to ON, the volume control of this unit cannot adjust the volume of the speakers connected to this unit. Volume adjustment shall be performed at the input device side such as the control amplifier connected to the MAIN IN terminal.

Entry of direct output into the MAIN IN terminal from a CD player or other devices that cannot adjust sound volume constantly provides a full power state and accordingly results in the risk of speaker damage.

For such input devices, be sure to use a control amplifier equipped with the sound volume adjustment function as a relay, generate sound through the speakers with volume lowered, and adjust the volume to your favorite level. When arranging the wiring, be sure to turn off the power of this unit.

* Pre-out terminal (PRE OUT) is kept output regardless of on/off state of the separate switch.

Names and Functions

Front panel

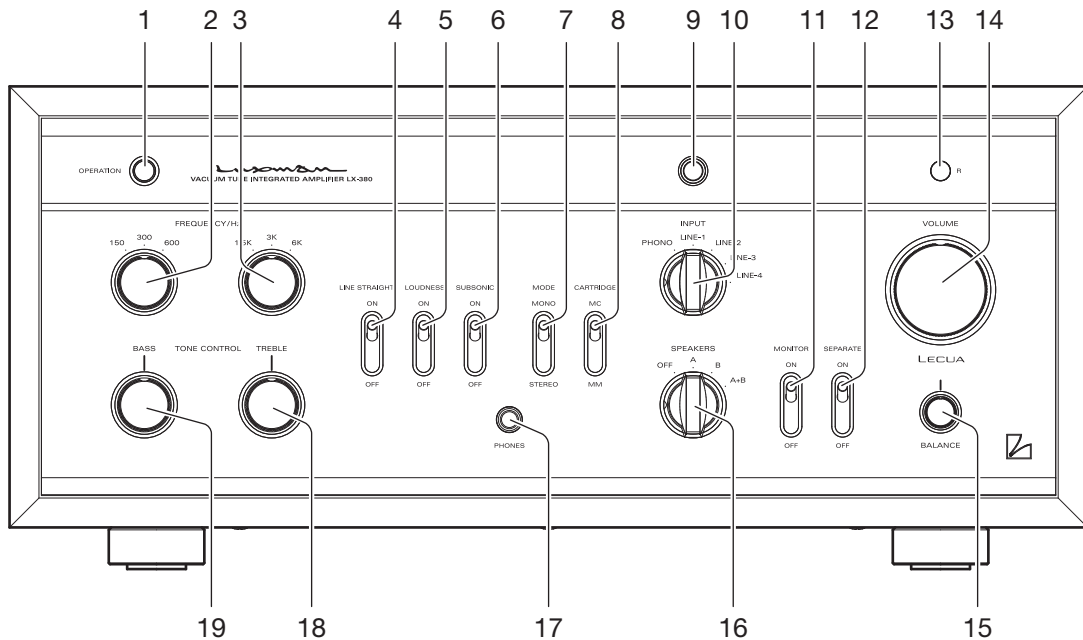

13. Remote sensor (R)

Receives signals from the accessory remote control. Do not block the front of the sensor.

14. Volume control (VOLUME)

Adjusts the sound volume. Sound is not generated when this control is rotated counterclockwise to the end, and then, the sound volume gradually becomes higher when the control is rotated clockwise as follows: mute → -87 dB → -86 dB → → 0 dB in steps of 1 dB. Also, it can be operated with the accessory remote control.

15. Balance control (BALANCE)

Adjusts the balance of sound volume between right and left channels.

Rotating this control counterclockwise makes the left sound volume enhanced, and rotating the switch clockwise makes the right sound volume enhanced. This control shall be set to the center position under normal conditions, and rotated to make adjustment if necessary.

When the line straight switch is set to on, this control does not function.

16. Speaker selector (SPEAKERS)

Selects either of 2 speaker systems, A or B, located at the rear panel.

OFF: Activates only headphones. No sound is generated from any speakers.

A: Selects the A system speaker terminal.

B: Selects the B system speaker terminal.

A+B: Simultaneously activates both A and B system speakers. When both speaker terminals are simultaneously used, select speakers with impedance of 8 ohms or more because both output terminals are connected in parallel.

17. Headphone jack (PHONES)

Insert the headphone plug into this output jack. Even when the plug is inserted, signals to the speaker output terminal are not interrupted. Accordingly, to listen to sound with only use of headphones, set the speaker selector to "OFF".

18. Tone control for treble

TONE CONTROL (TREBLE)

Controls the level of tone range higher than the selected one with "3. High frequency selector switch".

When this control is set to the center position, flat frequency characteristic is obtained. Rotating this control clockwise makes the high frequency range enhanced, and rotating this control counterclockwise makes the high frequency range attenuated.

When the line straight switch is set to on, this control does not function.

19. Tone control for bass (BASS)

Controls the level of tone range lower than the selected one with "2. Low frequency selector switch".

When this control is set to the center position, flat frequency characteristic is obtained. Rotating this control clockwise makes the low frequency range enhanced, and rotating this control counterclockwise makes the low frequency range attenuated.

When the line straight switch is set to on, this control does not function.

Names and Functions

Rear panel

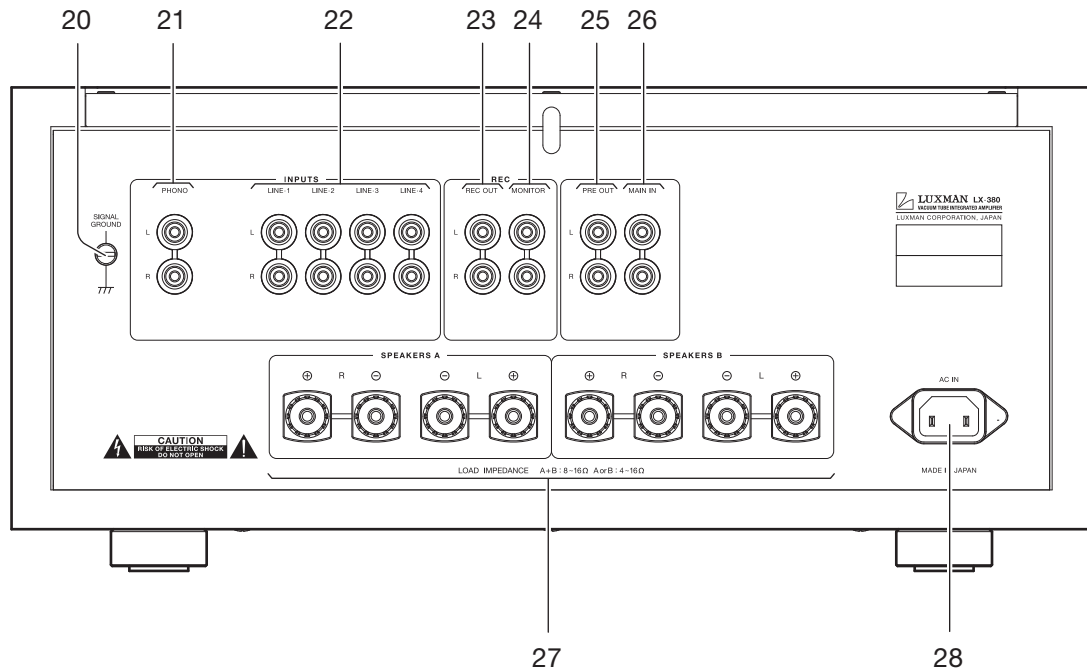

20. Signal ground terminal (SIGNAL GROUND)

Is a ground terminal for devices to be connected to this unit. These terminals are used to reduce noises when other devices are connected, and are connected to an analog player or a tone arm. This terminal is not designed for safety.

21. Phono input terminals (PHONO)

Are input terminals to connect RCA pin-plug cables from an analog player or a tone arm. Some analog players have internal phono equalizers. If that is the case, turn off the equalizer amplifier within the player.

Do not connect a CD player or other devices whose output level is high to this terminal. Normal playback cannot be provided due to sound crack.

* At the time of shipping, a shortpin plug is inserted to avoid noises. Remove the shortpin plug before using the unit. Also, do not insert the removed shortpin plug to the record output terminals (REC OUT) or Pre-out terminal (PRE OUT). No sound will be generated.

22. Line input terminals (LINE-1, LINE-2, LINE-3, LINE-4)

Are used for high-level signal inputs from a CD/DVD player, an SACD player, a tuner, a video deck, a TV, and other such devices. These input terminals offer the same functions.

23. Record output terminals (REC OUT)

Are used to transmit output signals for recording onto the recorder. These terminals are connected to the line input terminal of the recorder. The input signal selected with the input selector is outputted.

Do not insert shortpin plugs into REC OUT. No sound will be generated.

24. Monitor input terminals (MONITOR)

Are used to connect with the playback output terminal of the recorder. These terminals are connected to the line output terminal of the recorder. These terminals will be selected when the monitor switch is turned on regardless of the selected position of the input selector.

25. Pre-out terminals (PRE OUT)

Provide the output of the preamplifier section. A bi-amp connection can be performed with a combination of an external power amplifier because this terminal always provides output regardless of the separate switch setting.

Do not insert shortpin plugs into PRE OUT. No sound is generated.

26. Main in terminals (MAIN IN)

Provides input to the main-amplifier section directly when the pre-amplifier and main-amplifier are separated by setting the separate switch to on.

* The sound volume cannot be adjusted. Adjust the volume at the input device side.

27. Speaker terminals (SPEAKERS)

Connect speaker systems.

The right speaker terminals shall be connected to the R side, and the left speaker terminals shall be connected to the L side in consideration of the polarity.

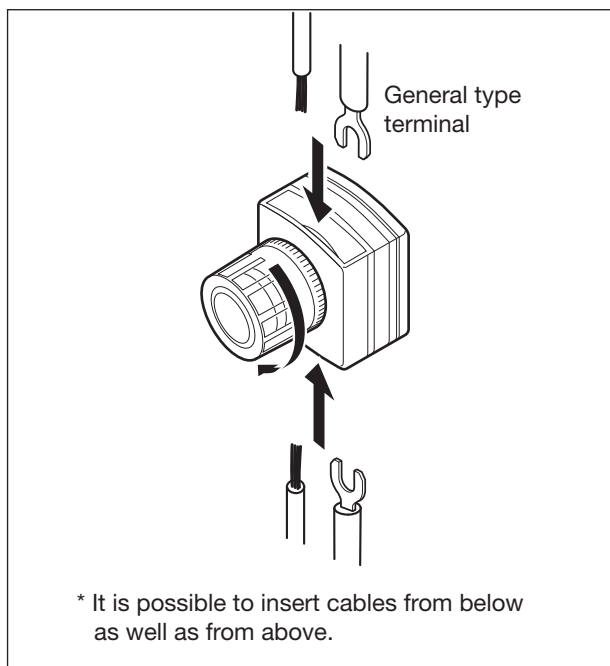

28. AC inlet (AC IN)

Connects the accessory power cable. The power shall be supplied from a household wall socket.



Note:

This symbol represents CLASSII apparatus with functional earth terminal. (Signal ground terminal)

Connections

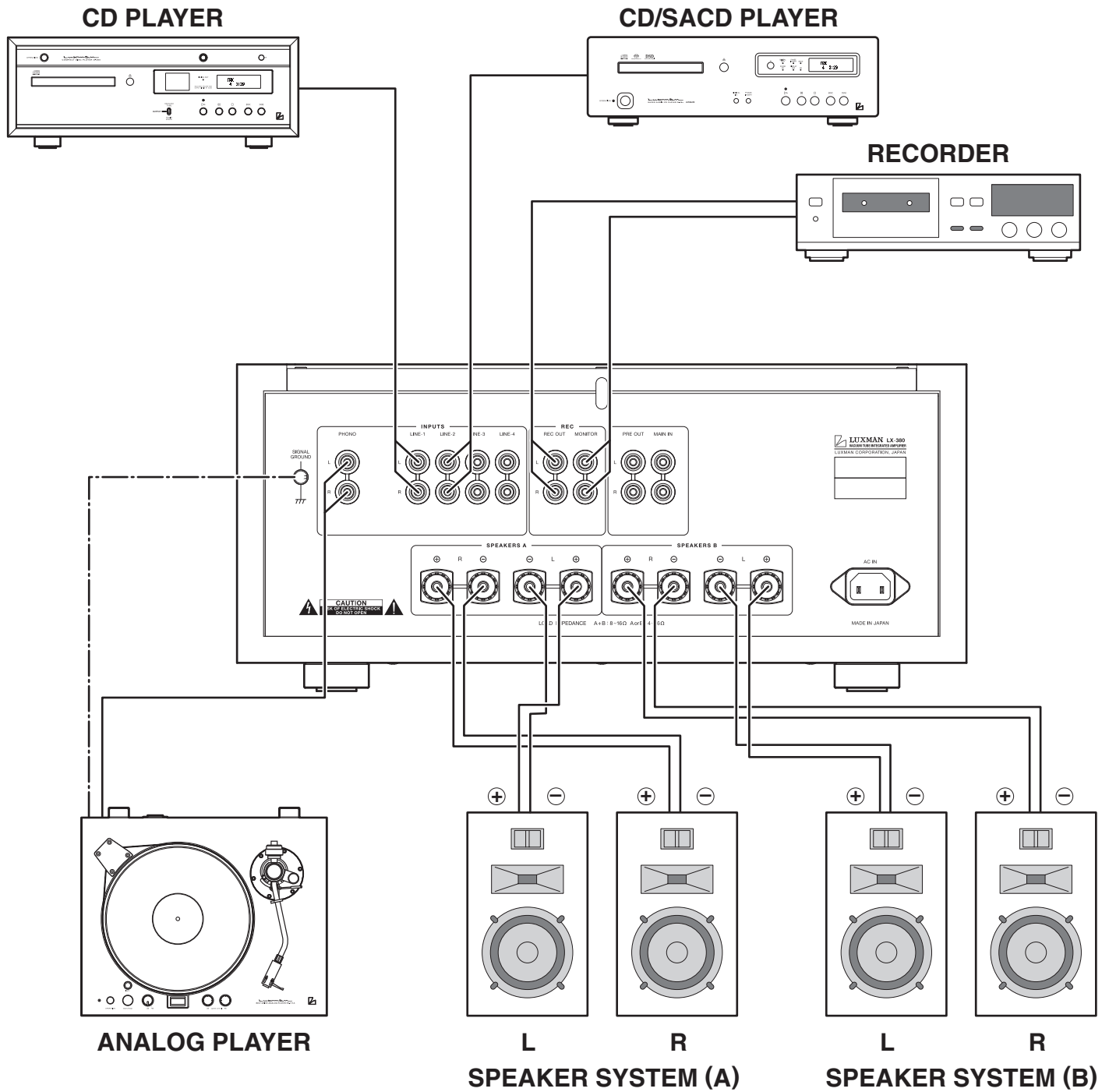

Before connecting

Before connecting other devices, connect the jack side of the accessory power cable to the AC inlet of this unit.

When connecting, turn off the power supply of this unit and the power supplies of auxiliary devices to prevent unexpected accidents that may be caused by noise.

How to connect power supply

Use the accessory power cable to insert the AC plug in an outlet on the wall in the listening room.

How to connect a CD player, SACD player, D/A converter, tuner, or other devices

Connect between the output terminals of a CD player, an SACD player, a D/A converter, a tuner, or other such input devices and the LINE-1 input terminals of this unit with 2 (R and L) pin-plug cables.

For LINE-2, LINE-3, and LINE-4 input terminals, connection in the same fashion as the LINE-1 terminals provides the same playback.

How to connect speakers

Connect the left-channel speaker to the L terminals of this unit and the right-channel speaker to the R terminals.

Securely connect the ⊕ terminal of the speaker system to the speaker terminal ⊕ (red) of this unit, and the ⊖ terminal of the speaker system to the speaker terminal ⊖ (black) of this unit.

If the ⊕ and ⊖ terminals are reversely connected to either of the right and left speaker systems, the acoustic phases of the sound reproduced from the right and left speaker systems are also reversed. In such a case, be aware that the sound level in the low range will be reduced and the acoustic stability will worsen, thus normal stereo playback cannot be achieved.

Connections

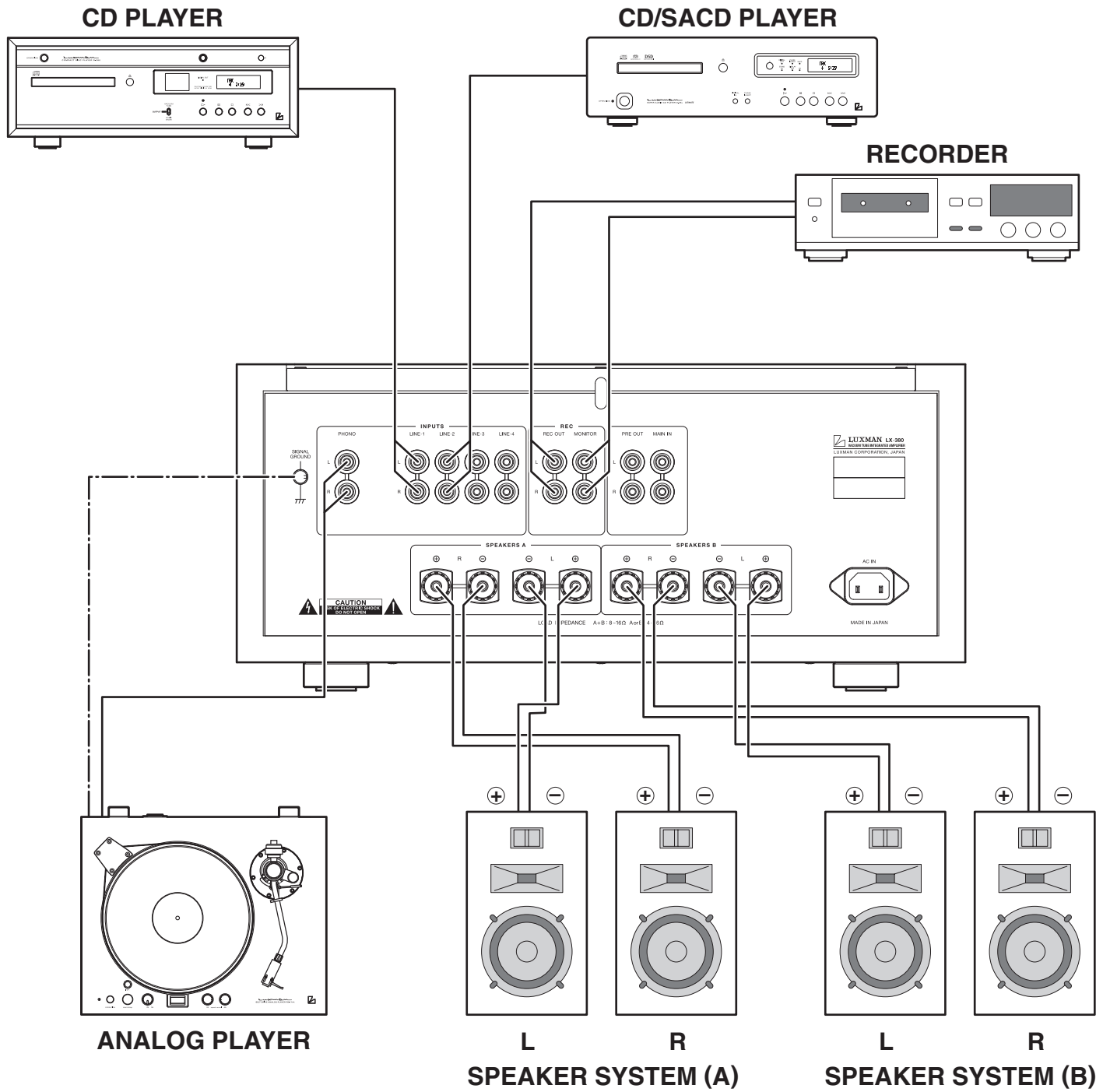

How to connect an analog player

Connect between the output terminals of an analog player and the PHONO terminals of this unit with 2 (R and L) pin-plug cables.

For some types of players, the ground wire from the phono motor or the tone arm should be connected to the ground terminal of this unit.

The phono equalizer of this unit is compatible with both the MM and MC cartridge. If an MC cartridge with low output voltage is used, set the cartridge selector on the front panel to the MC position.

The output from an analog player equipped with a phono equalizer or from an independent phono equalizer shall be connected to the line input terminals of this unit.

How to connect recorder

1. Connection to MONITOR terminals (playback)

Connect between the line output terminals (LINE OUT) of a recorder and the monitor terminals of this unit with pin-plug cables in consideration of L and R. When the monitor switch on the front panel is turned on, the playback of the recorder will become possible.

2. Connection to REC OUT terminals (recording)

When the sound source from the various input devices is played back, such as the PHONO or LINE terminals of this unit, the signals are also provided to the REC OUT terminal. Connection between the REC OUT terminal of this unit and the line input terminals (LINE IN) of the recorder with pin-plug cables is required for recording on the recorder. You can enjoy listening to the sound from the speaker system and record the sound at the same time. These output signals for recording are not affected by the control functions such as the volume control and tone control functions.

When you need not toggle an input source to be recorded (especially when a recorder connected to the recorder output terminals is recording), do not operate the input selector.

Do not insert shortpin plugs into REC OUT. No sound is generated.

When a CD recorder, tape recorder, or other devices are connected, be aware that the playback sound volume becomes low or no sound is generated if the device decreases the impedance of the line input terminals of the recorder extremely or causes short-circuit on the line input terminals when the recording switch is set to on.

How to connect PRE OUT/MAIN IN terminal

Either the pre-amplifier or main-amplifier can be separately used. When the pre-amplifier or main-amplifier is separately used, set the separate switch on the front panel to on. When only the pre-amplifier is used, connect the PRE OUT terminal of this unit to the input terminal of another power-amplifier, and when only the main-amplifier is used, connect the MAIN IN terminal of this unit to the output terminal of another control-amplifier.

When this amplifier is used without separating between pre-amplifier and main-amplifier, set the separate switch on the front panel to off, or no sound is generated.

Do not insert shortpin plugs into PRE OUT. No sound is generated.

The PRE OUT terminals keep outputting regardless of on/off state of the separate switch on the front panel.

Operations

Before operation

1. Ensure that the connections are correctly performed. (Normal playback cannot be achieved with wrong connections of R, L, ⊕, or ⊖.)
2. Whenever the power is turned on and off or the input selector is changed over, set the volume control to the minimum position in advance.

Playback procedure

1. Press the operation switch to turn on the switch after ensuring that the volume control is set to the minimum position.
2. Select a source to be played back with the input selector or with the monitor switch.
3. Adjust the sound level with the volume control.
4. Operate the line straight switch, balance control, and tone control according to the source to be played back.

How to operate line straight switch

The line straight switch is used to play sound with the shortest signaling route to enhance the purity of the source selected with the input selector. When this switch is set to on, the balance control, tone control, subsonic, monaural and loudness are bypassed.

How to operate balance control

The balance control allows users to adjust the balance of sound volume between right and left channels. When the balance adjustment is not required, the balance control should be set to the center position.

When the line straight switch is set to on, the balance control does not function.

How to operate tone control

This unit has the tone control function for the low frequency and high frequency ranges.

The low frequency tone control (bass) is a function to adjust the tone range lower than the selected one with the selector switch (FREQUENCY/Hz for low frequency). The tone control is set to flat frequency characteristics at the center position. Rotating the control clockwise makes the low frequency range enhanced, and rotating the control counterclockwise makes the low frequency range attenuated.

The high frequency tone control (treble) is a function to adjust the tone range higher than the selected one with the selector switch (FREQUENCY/Hz for high frequency).

The tone control is set to flat frequency characteristics at the center position. Rotating the control clockwise makes the high frequency range enhanced, and rotating the control counterclockwise makes the high frequency range attenuated. For both the low frequency and high frequency ranges, the right and left channels interlockingly function.

When the line straight switch is set to on, the tone control does not function.

How to record a source

1. Select a source to be recorded with the input selector.
2. Set the recording switch of the recorder to the recording standby state.
3. Play the source to be recorded and set the recorder to the recording state.

* Operation of the volume control, tone control, or balance control does not affect the recording signals.

Remote control (RA-25)

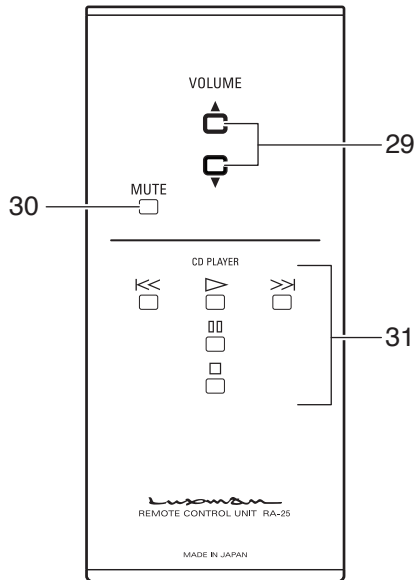

29. Volume (VOLUME ▲, ▼)

Adjusts the sound volume. The sound volume is lowered with ▼ and raised with ▲. The volume control of the main unit will turn.

30. Mute (MUTE)

Mutes the sound temporarily. Activation of the mute function causes the pilot light on the main unit to blink, and no sound is generated. Pressing this button again to cancel the mute function allows sound to be generated.

31. CD/SACD player operation switch (CD/SACD PLAYER)

This switch is used to control the corresponding CD/SACD players.

As of October 2016, the corresponding CD/SACD players are D-380, D-08u, D-06u, D-05u, D-08, D-06, D-05, D-10, D-7, D-600, and D-700S.

Remote control

The remote control shall be aimed at the remote sensor (R) of this unit within the specified angle range shown in the illustration below.

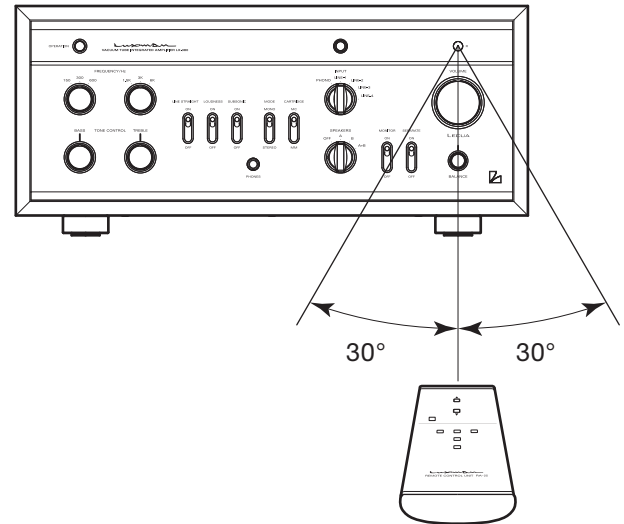

Effective distance:
approx. 5 meters

Dry cell battery

[How to load dry cells]

1. Put your finger on the battery cover claw located behind the remote control. The battery cover can be opened by pressing and sliding it downwards.
2. Put supplied 2 AAA batteries in the battery case as shown in the illustration.
3. Close the battery cover.

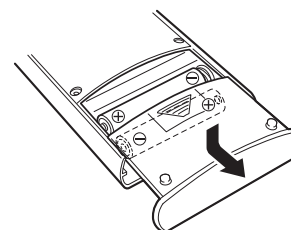

* When the batteries start to lose power, the effective distance becomes shorter or the unit does not function even though the switch is pressed. In such a case, both of the batteries should be replaced with new ones at the same time.

* If the remote control is not used for a long time, the batteries shall be removed from the case.

Block Diagram

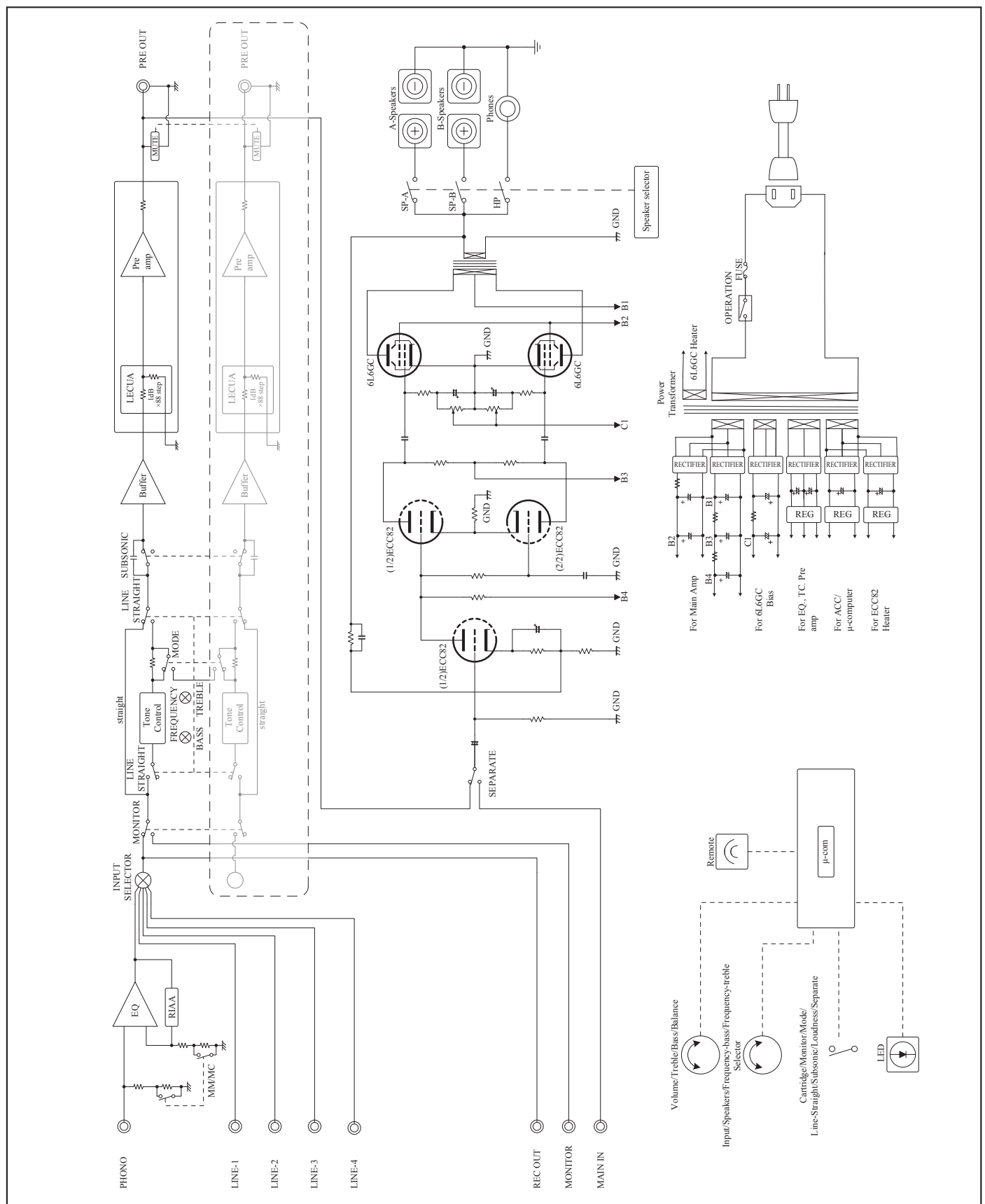

Specifications

Rated output	20 W + 20W (6Ω)	
Total harmonic distortion	1 % or less (1 kHz, 20 W/6 Ω, at stereo, with LINE STRAIGHT "ON")	
Pre-amplifier	PHONO (MM) : 3.0 mV/47 kΩ	
Input sensitivity/input impedance (PRE OUT: 1 V)	PHONO (MC) : 0.38 mV/100 Ω	
	LINE : 180 mV/47 kΩ	
	MONITOR : 180 mV/47 kΩ	
Main-amplifier	MAIN IN : 690 mV/100 kΩ	
Input sensitivity/input impedance		
Output voltage	REC OUT	: 180 mV
	PRE OUT	: 1 V
S/N ratio	PHONO (MM)	: 84 dB or more (PRE OUT, IHF-A correction, 3.0 mV input)
	PHONO (MC)	: 67 dB or more (PRE OUT, IHF-A correction, 0.38 mV input)
	LINE	: 95 dB or more
		(IHF-A correction, input shorted, LINE STRAIGHT "ON")
Frequency response	PHONO (MM)	: 20 Hz - 20,000 Hz (within ±0.5 dB, LINE STRAIGHT "ON")
	PHONO (MC)	: 20 Hz - 20,000 Hz (within ±0.5 dB, LINE STRAIGHT "ON")
	LINE	: 20 Hz - 80,000 Hz
		(within -3 dB, LINE STRAIGHT "ON")
Tone control	BASS (150 Hz)	: ±8.0 dB at 20 Hz
	BASS (300 Hz)	: ±8.0 dB at 40 Hz
	BASS (600 Hz)	: ±8.0 dB at 100 Hz
	TREBLE (1.5 kHz)	: ±8.0 dB at 10 kHz
	TREBLE (3 kHz)	: ±8.0 dB at 20 kHz
	TREBLE (6 kHz)	: ±8.0 dB at 40 kHz
Supplied functions	[Front panel]	
	• Operation switch	• Volume control
	• Input selector	• Balance control
	• Monitor switch	• Turnover frequency selector switch
	• Tone control	• Cartridge selection switch (MM/MC)
	• Separate switch	• Line straight switch
	• Subsonic switch	• Mode switch • Loudness switch
	• Speaker selector (OFF/A/B/A+B)	• Headphone jack
	[Rear panel]	
	• Input/output terminals	• Speaker terminals
• Signal ground terminal	• AC inlet	
[Remote control function]		
• Volume (up/down)	• Mute	
Circuit	Driver: Mullard circuit, Output: Beam tetrode connection	
Vacuum tube used	4x 6L6GC / 3x ECC82	
Accessories	• Remote control RA-25	• Power cable
	• Owner's Manual (This document)	• 2 pieces of "AAA" batteries
	• Safety cautions	
Power source	230 V ~ (50 Hz)	
Power consumption	127 W	
Max. external dimensions	440 (W) x 197 (H) x 403 (D) mm (front side knob with 25 mm and rear side terminal with 28 mm included in depth)	
Weight	17.6 kg (main unit)	

* Specifications and appearance are subject to change without notice.

Before Asking for Repair Service

While the unit is used, an unusual phenomenon may be confused as a malfunction for a certain reason. Prior to asking our official sole distributor of your country for repair services, please check the table below and read the operating instructions for the subsidiary devices. If the cause of the malfunction cannot be identified, please contact your dealer. When we have once accepted your request for repair services, inspection fees and traveling expenses may be claimed even though the unit is found to be normal.

Problem	Cause/Solution	Ref. page
No power is supplied even though the power switch is pressed ON.	<ul style="list-style-type: none"> The power plug is disconnected from the wall outlet, or it is not completely inserted. 	<ul style="list-style-type: none"> Insert the power plug in the wall outlet completely.
	<ul style="list-style-type: none"> The power jack is disconnected from the AC inlet, or it is not inserted completely. 	<ul style="list-style-type: none"> Securely insert the power jack in the AC inlet completely.
No sound is generated even though the power is on.(for both left and right channels)	<ul style="list-style-type: none"> A shortpin plug is inserted to REC OUT or PRE OUT. 	<ul style="list-style-type: none"> Remove the shortpin plug.
	<ul style="list-style-type: none"> The volume is muted. 	<ul style="list-style-type: none"> Cancel the MUTE mode.
	<ul style="list-style-type: none"> The input selector or monitor switch is not set to the source position to be played back. 	<ul style="list-style-type: none"> Set the input selector or monitor switch to the source to be played back.
	<ul style="list-style-type: none"> Cable connections are incomplete. 	<ul style="list-style-type: none"> Make cable connections securely.
	<ul style="list-style-type: none"> The output level of the input device is set to the minimum position. 	<ul style="list-style-type: none"> Adjust the output level.
No sound comes out from one side.	<ul style="list-style-type: none"> The connecting cable is not connected on one side only. 	<ul style="list-style-type: none"> Make cable connections securely.
Humming sound (boon or zzz noise) is generated.	<ul style="list-style-type: none"> The ground side of the pin-plug cable has no contact with the terminal. 	<ul style="list-style-type: none"> Make connections securely so that the ground side of the pin-plug cable makes contact with the terminal.
	<ul style="list-style-type: none"> The ground wire of the analog player is not connected. 	<ul style="list-style-type: none"> Connect the ground wire of the analog player to the SIGNAL GND terminal.
	<ul style="list-style-type: none"> Connections or mounting conditions are incomplete between the cartridge and shell, or between the shell and tone arm of the analog player. 	<ul style="list-style-type: none"> Connect (or mount) the cartridge, shell, and tone arm securely.
	<ul style="list-style-type: none"> The connecting cables are too close to the power cable. 	<ul style="list-style-type: none"> Keep the connecting cables away from the power cable.
	<ul style="list-style-type: none"> Induction noise is picked up from a power transformer of another device. 	<ul style="list-style-type: none"> Install it distant from other devices.
	<ul style="list-style-type: none"> The line straight switch is set to ON. 	<ul style="list-style-type: none"> When tone control or balance control is used, the line straight switch shall be set to OFF.
The subsonic, monaural or loudness is not activated.	<ul style="list-style-type: none"> The line straight switch is set to ON. 	<ul style="list-style-type: none"> When the subsonic, monaural or loudness is used, the line straight switch shall be set to OFF.

MEMO

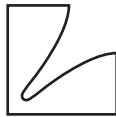

LUXMAN CORPORATION, JAPAN

1-3-1 Shinyokohama, Kouhoku-ku, Yokohama-shi, Kanagawa 222-0033, Japan

AG00987E60A
Printed in Japan