

LUXMAN

INTEGRATED AMPLIFIER
L-509X



The realisation of a desirable ideal —
the ultimate refinement of separates in a single unit.



The L-509X integrates the features of both a high quality separate amplifier and a high performance integrated amplifier into one product.

The goal of creating an ideal integrated amplifier, initiated by LUXMAN with the launch of the L-509fSE in 2002, has now been advanced with the development of the L-509X.

The L-509X integrated amplifier is equipped with many desirable features, such as the New LECUA1000 and a discretely configured buffer circuit in the output stage of the pre-amplifier circuit.

LUXMAN's ODNF (Only Distortion Negative Feedback) original amplifier feedback circuit and a power supply with independent left and right channel blocking capacitors are intrinsic to this design, as well as many components used only in high end models, ensuring high-quality audio reproduction.

The design of the L-509X incorporates the cream of LUXMAN's proprietary technologies, breaking new ground and creating the ultimate expression of “separates in a single unit”.

ODNF* Version 4.0 innovative amplification feedback circuit



ODNF Version 4.0 power amplifier block

An integral part of the design of the L-509X is LUXMAN's original ODNF* amplification feedback circuit, featuring a high-speed primary slew rate, an ultra-wide bandwidth and a low level of distortion that is achieved by feeding back only the distorted components of the audio signal from the output of the amplification circuit. The L-509X is equipped with the latest Version 4.0 ODNF providing a dramatic enhancement of accuracy in distortion detection due to the triple-paralleled first stage error detection circuit. Lower impedance and a higher signal to noise ratio have been achieved due to the paralleled first stage and Darlington equipped second stage amplification circuit. A 3-stage Darlington circuit and a 4-parallel push-pull structure is used for the output stage, similar to the M-700u power amplifier. This achieves output at 120W+120W(8Ω) and 220W+220W(4Ω), enabling the L-509X to drive speakers powerfully with rich dynamics and full expression.

*ODNF stands for "Only Distortion Negative Feedback".



Top panel

Chassis structure exemplifies excellence in function and design

The L-509X features a top panel with a beautiful hair-line finish and widened venting to improve heat dissipation. The loop-less chassis structure restricts any increase in ground impedance. Analog level meters, illuminated with white LEDs, add to the elegant and stylish appearance.

An abundance of user-friendly functions

The L-509X is equipped with a high-quality phono amplifier, compatible with MM and MC cartridges. This model offers all the functions that a high quality integrated amplifier should, including bass and treble tone controls, L/R balance adjustment controlled by LECUA, pre/power separation function, volume control and headphone output, all integrated into a single unit without compromising sound quality.



Analog meters and control knobs

Copper alloy terminals

High quality RCA terminals, made of copper alloy, are used for the LINE-1 inputs of the L-509X, combining the beneficial conductivity of copper and durability of brass. The L-509X features many custom-made components befitting a flagship model, such as the robust power supply and high-grade speaker terminals that are compatible with Y-connectors.



Copper alloy terminals

Gradation cast-iron feet

Thorough vibration countermeasures have been taken, using cast iron feet with a density gradient to eliminate resonance. The high grade, aluminium body remote control is also supplied as standard.



Gradation cast-iron feet

High stability power supply



Power supply unit featuring large-capacity components

The highly stable power supply circuit developed for the L-509X features a 600 VA EI-core-type power transformer and independent left and right channel large capacity blocking capacitors (10,000μF×4 per channel). This generous custom specification ensures that the power supply unit will not be affected by any load fluctuation.

Discrete buffer circuit

The L-509X is equipped with a discrete buffer circuit that is equivalent to the type used in the high-end LUXMAN C-900u separate amplifier. The clarity of the audio signal is preserved by this circuit whilst at the same time the following power amplification stage's driving force is significantly increased.

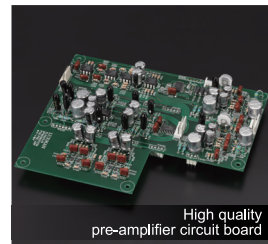

High quality pre-amplifier circuit board

Prioritizing audio quality in design

The use of crack-resistant peel coat PCBs for the amplifier boards prevent the quality of audio signals being adversely affected. This product prioritizes audio quality in features such as the non-angled, direct wiring pattern, known as the original LUXMAN's Beeline construction, ensuring smooth signal transmission via the optimum shortest route.

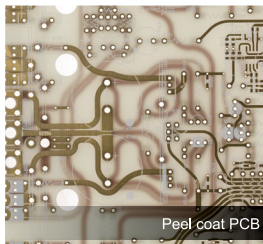

Peel coat PCB

Increased damping factor

Large-capacity, low resistance speaker relays are connected in parallel, enabling loss-less transmission of the powerful driving force that is generated by the generous power supply circuit and the amplifier output section of the L-509X. The use of 3.5mm² cabling for the amplifier board output and the unit's damping factor of 370 enables the L-509X to drive all kinds of speakers accurately.

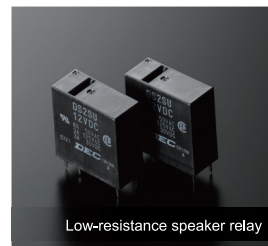

Low-resistance speaker relay

New LECUA*1000 computerized attenuator

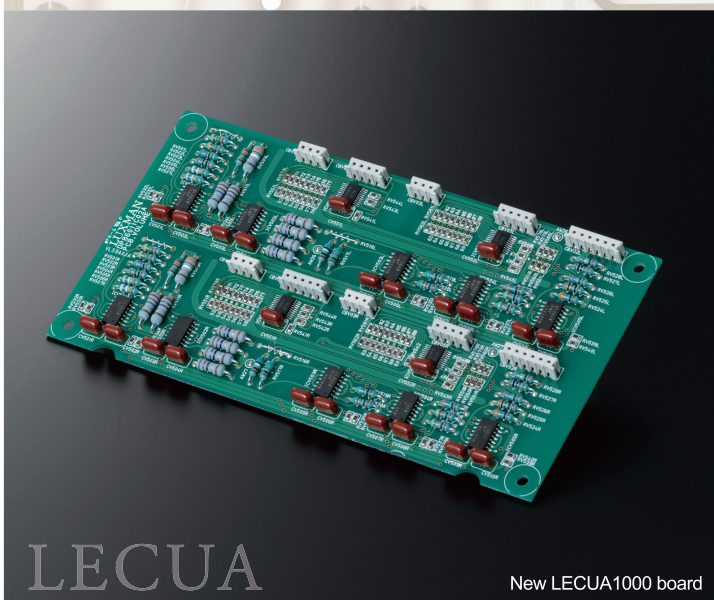

LECUA

New LECUA1000 board

LUXMAN's New LECUA1000 is at the heart of the preamp section and the volume adjustment control of the L-509X. This computerized attenuator is integrated with the amplification circuit, a feature integral to the high-end LUXMAN C-900u control amplifier. LECUA provides an ideal level control system which allows smooth and fine adjustment of the volume over 88 steps, thereby minimising the deterioration of audio quality at any point of the volume adjustment range. An advancement of the New LECUA1000 is the 3D design layout. The attenuator circuit board is directly connected to the amplification circuit board. Signal routing has been minimized and efficiency has been successfully enhanced. In addition, this design is extremely resistant to external vibration and eliminates changes in audio quality over the volume control range. The robust nature of this system ensures longevity and durability.

*LECUA stands for "Luxman Electronically Controlled Ultimate Attenuator".

L-509X INTEGRATED AMPLIFIER

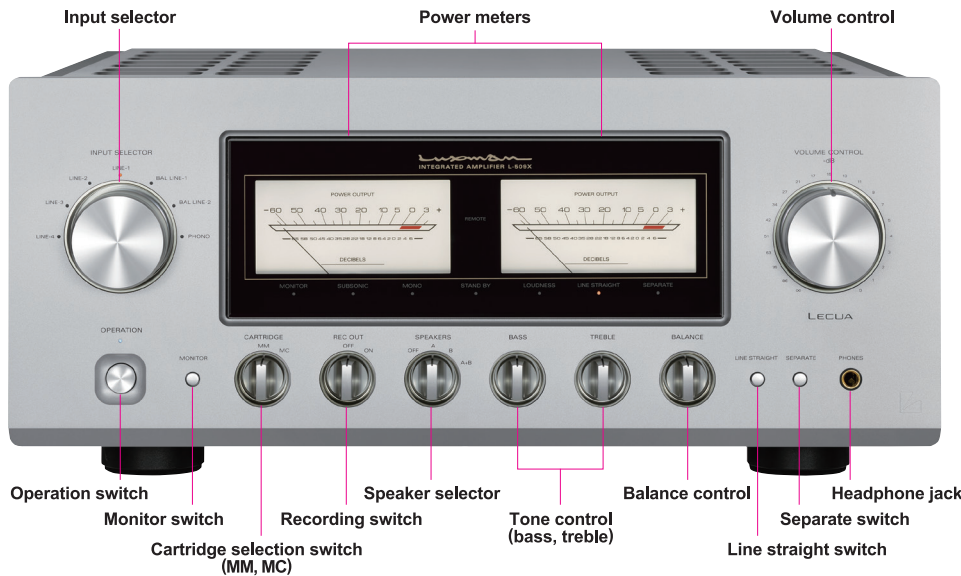

Remote control RA-17A

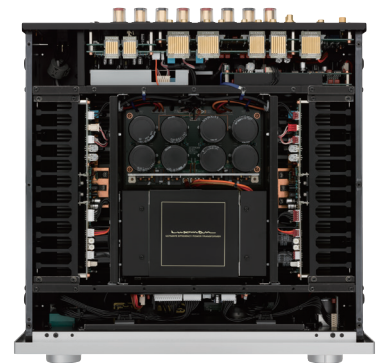
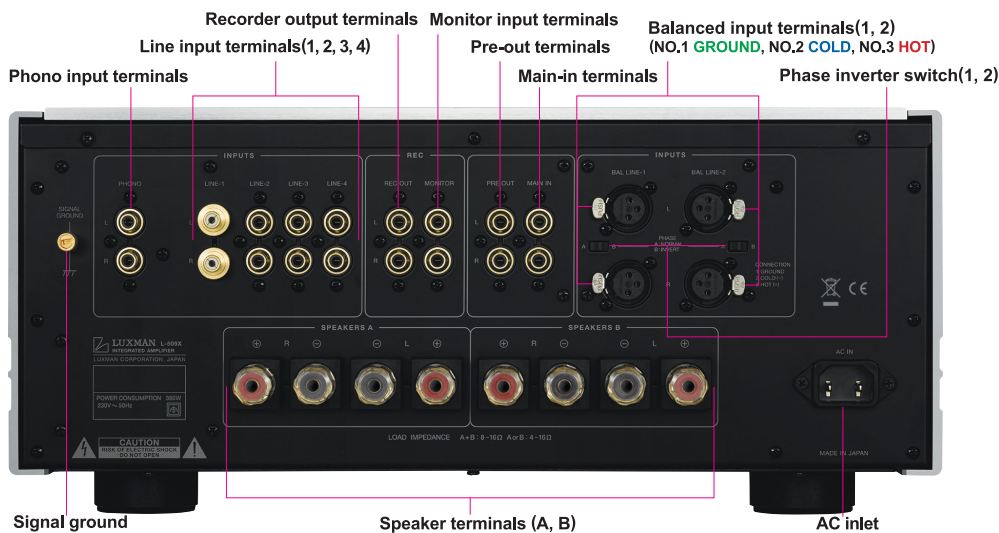

Internal configuration

*Rear panel : European Model

SPECIFICATIONS

Rated output	120W + 120W (8Ω), 220W + 220W (4Ω)
Input sensitivity/ input impedance	PHONO (MM) : 2.5mV/47kΩ PHONO (MC) : 0.3mV/100Ω LINE : 180mV/47kΩ BAL.LINE : 180mV/55kΩ MAIN IN : 1.1V/47kΩ
Output voltage	REC OUT: 180mV, PRE OUT: 1V
Frequency response	PHONO : 20Hz to 20kHz (±0.5dB) LINE : 20Hz to 100kHz (within -3dB)
Total harmonic distortion	0.007% or less (8Ω, 1kHz) 0.06% or less (8Ω, 20Hz to 20kHz)
S/N ratio (IHF-A)	PHONO (MM) : 91dB or more PHONO (MC) : 75dB or more LINE : 105dB or more
Volume adjustment	New LECUA1000
Amplification circuit	ODNF 4.0
Output configuration	Bipolar 4-parallel push-pull
Damping factor	370

Max. amount of tone control	BASS: ±8dB at 100Hz TREBLE: ±8dB at 10kHz
Power supply	230V~(50Hz) / 115V~(60Hz)
Power consumption	380W 150W (under no signal), 0.5W (at standby)
External dimensions	440(W) x 193(H) x 463(D) mm front side knob of 20mm and rear side terminal of 37mm included in depth
Net weight	29.3kg (main unit)
Accessories	Remote control (RA-17A) Power cable
Speaker terminal Supported Y-lug terminal dimension	Width of part a: 16mm or less Width of part b: 7mm or more

* Connection may not be performed depending on the shape of the Y-lug terminal.

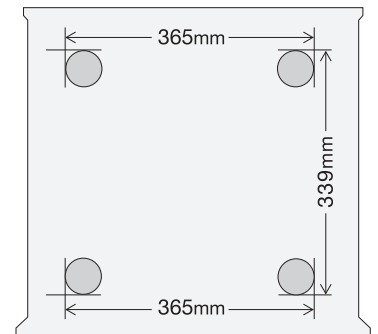

* Setting the phase inverter switch to the B position allows balance input terminal No 2 to change to **HOT**, and No. 3 to **COLD**.

* Specifications and appearance are subject to change without notice. * The products listed in this catalog do not include line cables. Please purchase cables separately.

LUXMAN

LUXMAN CORPORATION, 1-3-1 Shinyokohama, Kouhoku-ku, Yokohama-shi, Kanagawa 222-0033, Japan
Tel: +81-45-470-6980 Fax: +81-45-470-6997 www.luxman.co.jp

LUXMAN reserves the right to alter the design and specifications without notice.
All rights reserved LUXMAN CORPORATION



⚠ Safety Cautions

To ensure correct use of this product, read the "Owner's Manual" prior to use. Failure to follow all safeguards can result in fire, electric shock, or other accidents.